

HOMEOWNER'S MANUAL

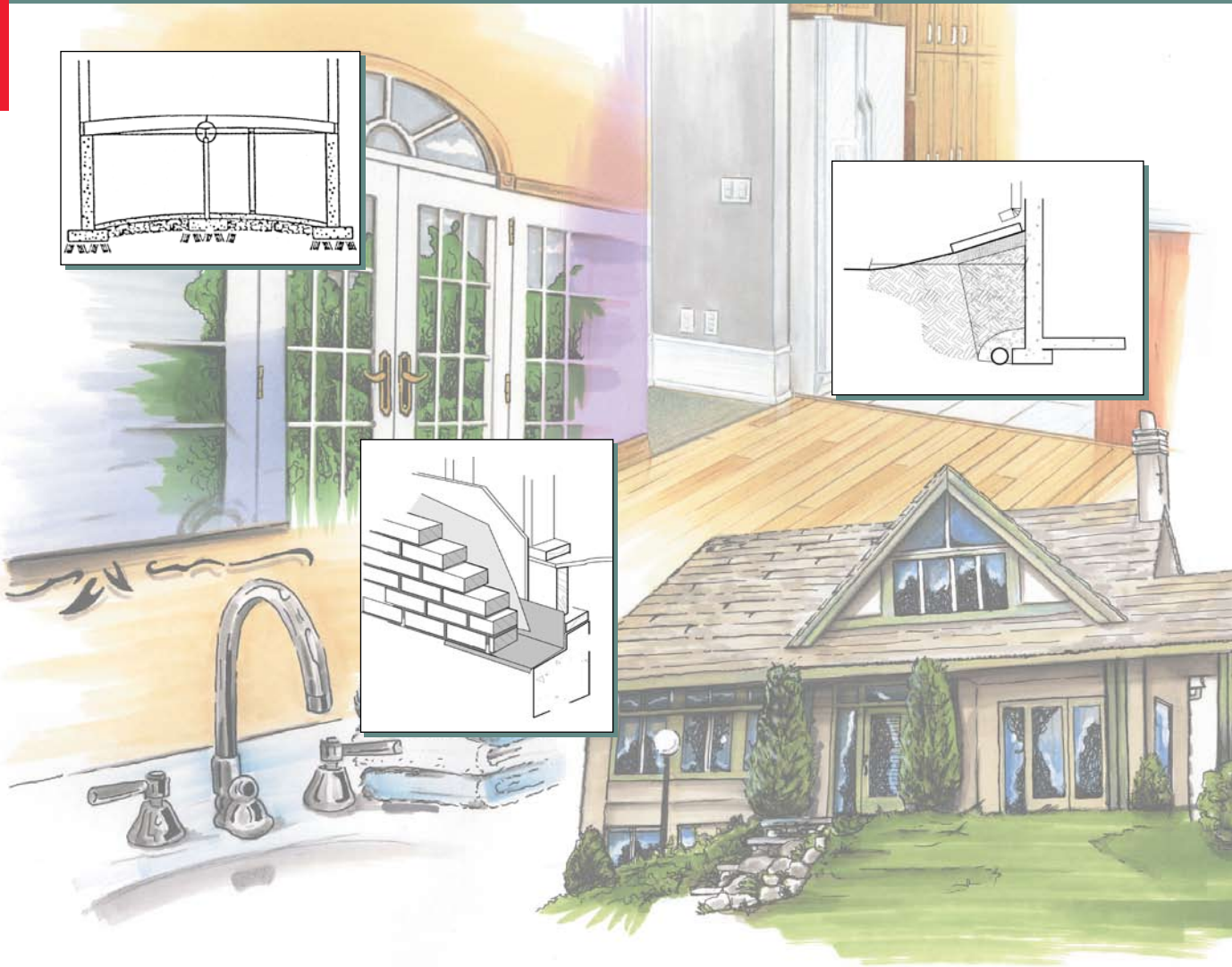



CMHC—HOME TO CANADIANS

Canada Mortgage and Housing Corporation (CMHC) has been Canada's national housing agency for more than 60 years.

Together with other housing stakeholders, we help ensure that the Canadian housing system remains one of the best in the world. We are committed to helping Canadians access a wide choice of quality, environmentally sustainable and affordable homes – homes that will continue to create vibrant and healthy communities and cities across the country.

For more information, visit our website at [**www.cmhc.ca**](http://www.cmhc.ca)

You can also reach us by phone at 1-800-668-2642 or by fax at 1-800-245-9274.

Outside Canada call 613-748-2003 or fax to 613-748-2016.

Canada Mortgage and Housing Corporation supports the Government of Canada policy on access to information for people with disabilities. If you wish to obtain this publication in alternative formats, call 1-800-668-2642.

HOMEOWNER'S MANUAL

CMHC offers a wide range of housing-related information. For details, call 1 800 668-2642 or visit our website at www.cmhc.ca

Cette publication est aussi disponible en français sous le titre : Manuel du propriétaire-occupant 62096

National Library of Canada cataloguing in publication data

Main entry under title :

Homeowners's manual

Issued also in French under title : Manuel du propriétaire-occupant.

ISBN 0-660-18815-5

Cat. no. NH15-386/2003E

I. Dwellings – Maintenance and repair – Amateurs manual.

I. Canada Mortgage and Housing Corporation.

TH4817.3H65 2003

643'.7

C2003-980159-4

Reprinted: 2005, 2006, 2008

The information contained in this publication represents current research results available to CMHC and has been reviewed by a wide spectrum of experts in the housing industry. This publication is not, however, intended to replace appropriate professional resources. Readers are advised to evaluate the information, materials and techniques cautiously for themselves and to consult appropriate professional resources to determine whether the information, materials and techniques are suitable given their specific circumstances, including but not limited to unit, project and site. The drawings and texts are intended as general practical guidance only and may not be applicable to the reader's specific circumstances. CMHC assumes no responsibility for any consequences arising from the reader's use of the information, materials and techniques described herein or from the reader's reliance thereon.

© 1999 Canada Mortgage and Housing Corporation. All rights reserved. No portion of this book may be reproduced, stored in a retrieval system or transmitted in any form or by any means, mechanical, electronic, photocopying, recording or otherwise without the prior written permission of Canada Mortgage and Housing Corporation. Without limiting the generality of the foregoing no portion of this book may be translated from English into any other language without the prior written permission of the Canada Mortgage and Housing Corporation.

Printed in Canada

Produced by CMHC

Acknowledgements

This manual owes its existence and quality to many people. At the Canadian Home Builders' Association, Ross Monsour, Don Johnston and Michael Gough supported its creation and assisted CMHC in putting together a National Advisory Committee. The National Advisory Committee members brought intimate knowledge of new homeowners and builders and extensive knowledge of the issues that arise in the operation and maintenance of a house. Its members were:

Lynn Woodcroft, Ontario NHW
Bruno Nantel, NHWP of APCHQ
Jerry Kondi, NHWP Manitoba Inc.
Glen Silliphant, NHWP of Saskatchewan
Dennis Little, Alberta NHWP
Pat Mulcahy, Atlantic HWP
Rosalie Todd, Consumers Association
Norm Lecuyer, Canadian Association of Home Inspectors
Neil Ziola, Sure-Lok Homes Ltd.
Charlie Spillane, Ontario Home Builders' Association
Richard Lind, Edwards Lind Enterprises Ltd.
Frank Szadkowski, NRCan

Prepared for CMHC by Marbek Resource Consultants.

Endorsement

“Your new car comes with an operator’s manual, and the Canadian Home Builders’ Association (CHBA) believes your new home should come with an operator’s manual too.

The new *Homeowner’s Manual* is your guide to your new home. It tells you what you need to know, from routine upkeep to dealing with emergencies.

The CHBA is proud to have been a part of the team that developed the new *Homeowner’s Manual*. We are committed to building the best and ensuring that you have peace of mind and enjoy your new home.”

–Canadian Home Builders’ Association

Table of Contents

Introduction

This Manual: What It's About and How to Use It	5
Guide to Common Problems	8

Part One

The Whole House — An Overview	13
The Environment in Your House	17
Controlling Moisture	17
Maintaining Air Quality in Your Home	20
Ensuring Energy-efficient Operation	23
A Safe and Secure Home	26
The First Year	30
Warranty Reminder and Maintenance Calendar	33

Part Two

SITE	39
Grading and Drainage	41
Landscaping and Vegetation	43
Driveways, Walkways and Paved Patios	46
FOUNDATION AND BASEMENT	49
Foundation Wall	50
Basement or Crawl Space Floor	52
Sump System	53
Teleposts	55

Table of Contents

ROOF, OUTSIDE WALLS, OTHER EXTERIOR FEATURES	57
Roof	58
Exterior Finish: Wood, Siding and Wood Trim	62
Exterior Finish: Fiberboard, Vinyl or Metal Siding	64
Exterior Finish: Masonry	66
Exterior Finish: Stucco	68
Eavestroughs	69
Caulking	71
Stairs, Porches and Decks	73
Garage or Carport	75
DOORS AND WINDOWS	79
Doors	81
Windows	84
INTERIOR FINISHES	87
Hardwood Floors	89
Resilient Flooring	91
Stone or Ceramic Tile	93
Carpeting	94
Drywall (Wallboard)	96
Countertops and Cabinets	99
HEATING, VENTILATION AND AIR CONDITIONING	101
Heating: Gas Furnace	103
Heating: Oil Furnace	107
Heating: Electric Furnace	111
Heating: Propane Furnace	114

Table of Contents

Integrated Heating and Hot Water System	117
Electric Baseboard Heating	120
Wood Fireplace or Heating Stove	121
Gas Fireplace or Heating Stove	124
Heating and Cooling System: Heat Pump	126
Cooling System: Central Air Conditioning	129
Distribution System: Forced Air Duct System	132
Thermostat	134
Ventilation System: Exhaust Fans	136
Ventilation System: Heat Recovery Ventilator	139
PLUMBING AND HOT WATER	143
Shut-off Valves	146
Hot Water Tank	148
Faucets	151
Drains and Traps	153
Bathroom Sinks, Tubs and Shower Enclosures	157
Toilets	159
Outside Faucet (Hose Bib)	162
Well Water Supply System	164
Septic System or Holding Tank	166
ELECTRICAL SYSTEM	169
System Overview	169
Important Safety Tips	170
Operation and Maintenance	171

Table of Contents

THIS MANUAL: WHAT IT'S ABOUT AND HOW TO USE IT

The Purpose of This Manual

This manual is a tool to help you take good care of your new house. Your new house is one of the biggest and most important purchases you'll ever make. You and your builder have gone to a lot of trouble to make sure the house is one you can be proud of and live in comfortably for many years to come. Now, you need to follow through by learning about the proper operation and upkeep of a range of building systems and structures. Of course, you have a home warranty plan, and that gives you some security in case of trouble; but there are a hundred ways a householder can prevent trouble from ever arising, or solve problems the minute they become apparent. To do that, if you're like most people, you need some of the focused information and advice that is contained here.

This Manual Will:

- help you to understand the workings of your house — its key systems and components, how they work and how they fit together;
- tell you how to maintain those systems and components at a basic level;
- offer troubleshooting advice on how to resolve common problems; and
- share some tips on how to run your house in a healthy, efficient and environmentally friendly way.

This Manual Will Not:

- describe in detail how your house is constructed;
- replace the operations and maintenance manuals provided by the manufacturers of specific equipment; or
- serve as a complete home repair guide or substitute for publications dealing with specific topics (healthy homes, energy efficiency, etc.).

Finding Your Way Through The Manual

Refer first of all to the *Table of Contents*, which lists every topic covered in the manual. Then, glance at the table called, *Guide to Common Problems*, page 8: here, you'll find a brief explanation of some of the

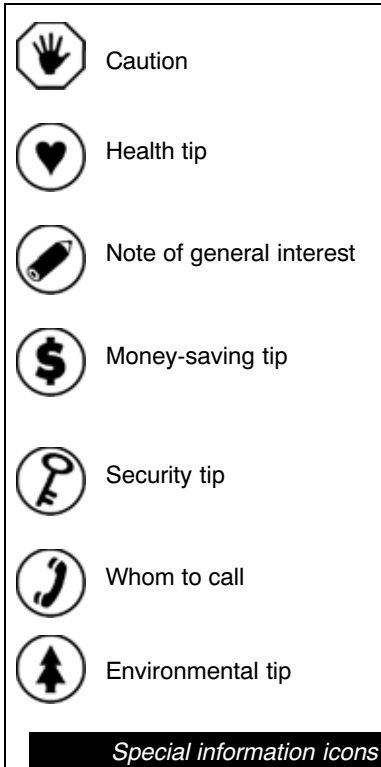

most common problems that homeowners face. Page references on this table show you where to go in the manual for more information.

The manual is organized as follows:

PART 1 (five sections) introduces key information and concepts that are common to all homes. *The Whole House — An Overview* shows how a typical house is put together. *The Environment in Your House* will help you to understand and control factors that affect humidity, air quality and energy use. *A Safe and Secure House* introduces issues that can affect the well-being of your house and the people living in it. *The First Year* charts common changes during the initial period of adjustment of the new house. Finally, the *Warranty Reminder and Maintenance Calendar* will help you stay on top of warranty reporting and basic upkeep.

PART 2 (eight sections) contains information on eight different structural or functional parts of the house, with information on the systems, components and materials found in your house: note that information applying to your situation has been selected; that which does not apply has been left out. In this way, the manual has been customized to your house. All sheets are structured the same way, beginning with general background (*Description* or *Overview*), followed by guidance on *Operation and Maintenance*, as well as *Troubleshooting* advice and *Additional Tips*. Get to know your way around Part 2 of the manual: flip through the pages and browse a little so that when you need help, you can zero right in on the relevant section. A series of “icons” highlight special kinds of information.

Cross-referencing

We have cross-referenced this manual throughout to guide you in your search for information. Keep an eye out for italicized words in the text, for example:

“Maintain easy access to all plumbing *Shut-off Valves*, page 146.”

This is a reference directing you to the information on *Shut-Off Valves* in Part 2, page 146. Turn to that section if you need more help.

Whom to Contact?

Sometimes, this manual — having introduced and explained a system or problem — suggests that you call your builder or seek other expert assistance. Well, which is it? The builder or somebody else?

The First Year: Within one year of buying a new house, you should look to your builder as the logical first point of contact for problems of workmanship or materials. Remember, minor problems are common in the settling-in period. The best approach is simply to keep track of problems and notify the builder and your warranty plan before the end of the first year. On the other hand, if a significant problem or emergency comes up in the first year, contact your builder right away. (Of course, the builder is not responsible for damage caused by misuse or accident, or for problems with appliances or materials that another firm installed.)

The Second Year: Under some new home warranty plans, the builder warrants against certain problems for two years from date of possession. Because the warranties vary so much between the houses and plans, it is hard to generalize.

Five to Ten Years: New home warranty plans usually offer a five-, seven-, or ten-year warranty for significant structural problems. In the unlikely event of such a problem, contact the plan directly.

No Warranty: If the problem you are dealing with is not under warranty, or if the warranty has expired, contact a building contractor or specialized expert.

Caution!

Home maintenance and repair work can be dangerous. Before going ahead on your own, weigh the risks to your house, yourself and your family. If you are not clear about the problem and how to fix it, if you are unfamiliar with the tools or uncertain of the skills needed, by all means hire an expert. Even if you don't do the work yourself, this manual will help you understand and manage the work of a contractor. If you do choose to proceed on your own, pay attention to the safety advice offered in this manual and wear appropriate footwear and protective gear. Always consult the manufacturer's instructions before undertaking maintenance or repair work on equipment.

GUIDE TO COMMON PROBLEMS

Got a particular problem in your house? Scan this alphabetical listing for hints on how to deal with it and where to find more information in the pages that follow.

TOPIC	Where to look in this manual?
<p>Cold rooms If certain rooms in the house are too cold (or too hot), the heat distribution system may need to be rebalanced.</p> <p> If the floor or the surface of an exterior wall is cold or drafty, the problem may lie with the air sealing or insulation rather than the heating system. Contact your builder or a contractor for advice.</p>	<ul style="list-style-type: none"> • <i>Forced Air Duct System</i>, page 132. • <i>Electric Baseboard Heating</i>, page 120.
<p>Condensation If moisture forms on windows, mirrors, basement pipes or other hard surfaces, there is probably too much humidity in the air inside your house. A number of things can cause high humidity.</p>	<ul style="list-style-type: none"> • <i>The Environment in Your House</i>, page 17. • <i>Roofs</i>, page 58. • <i>Exhaust Fans</i>, page 136. • <i>Heat Recovery Ventilator</i>, page 139.
<p>Cracks — foundation, basement floor slab Hairline cracks are generally not a problem, unless water is leaking in through them. However, large cracks or bulges need to be looked at.</p>	<ul style="list-style-type: none"> • <i>The First Year</i>, page 30. • <i>Foundation Walls</i>, page 50. • <i>Basement or Crawl Space Floor</i>, page 52.
<p>Cracks or gaps — exterior cladding Minor gaps in the siding may be temporary (occurring only in cold weather) and may not be a problem if the siding continues to shed water. For reassurance, contact your builder. Similarly, hairline cracks in stucco or in the mortar between bricks are common and not generally a cause for concern. Larger cracks, or cracks causing leaks, deserve attention.</p>	<ul style="list-style-type: none"> • <i>The First Year</i>, page 30. • <i>Exterior Finish</i>, page 57.
<p>Cracks or gaps — in drywall, or between walls and cabinets, vanities, bathtub enclosures Minor cracks or gaps and nail pops in drywall are common and can be easily repaired. Large cracks or gaps may signify more serious structural problems.</p>	<ul style="list-style-type: none"> • <i>The First Year</i>, page 30. • <i>Caulking</i>, page 71. • <i>Drywall (Wallboard)</i>, page 96.

TOPIC	Where to look in this manual?
<p>Doors or windows jamming, rubbing or refusing to close Changes in humidity can affect wooden doors. Settlement, which is potentially serious, can cause doors or windows to be “out of square.”</p>	<ul style="list-style-type: none"> • <i>The First Year</i>, page 30. • <i>Doors</i>, page 81. • <i>Windows</i>, page 84. • At the end of this table, see also the note on “Major Structural Defects.”
<p>Drafts — around doors or windows The hardware for closing doors or windows in a new house may need adjustment or, after a while, the weather-stripping may need replacing. Gaps too large to be weather-stripped may point to a structural defect.</p>	<ul style="list-style-type: none"> • <i>General Information</i>, page 79. • <i>Doors</i>, page 81. • <i>Windows</i>, page 84.
<p>Dry air If there is a central ventilation system, it may be operating too often or at too high a speed. Air that is too dry can irritate the respiratory system (e.g., nose and sinuses), and can cause wood to crack.</p>	<ul style="list-style-type: none"> • <i>Heat Recovery Ventilator</i>, page 139.
<p>Electrical circuit not functioning (no power to lights or appliances) A circuit breaker at the electrical panel or a ground fault circuit interrupter may have tripped due to a faulty appliance, an overloaded circuit, a power surge, or faulty wiring.</p>	<ul style="list-style-type: none"> • <i>General Information</i>, page 169.
<p>High heating and cooling costs New houses are energy-efficient, so it should be easy to keep heating and cooling costs down. If not, there are many steps a homeowner can take to cut down on the energy used.</p>	<ul style="list-style-type: none"> • <i>The Environment in Your House</i>, page 17. • <i>Caulking</i>, page 71. • <i>General Information</i>, page 79. • <i>Heating, Ventilation and Air Conditioning</i>, page 101.
<p>Leaks — basement Many things can cause a basement to leak. To prevent structural and other damage, address the problem quickly.</p>	<ul style="list-style-type: none"> • <i>Grading and Drainage</i>, page 41. • <i>Foundation</i>, page 50. • In this table, see also “Condensation” and “Leaks — plumbing.”

Guide to Common Problems

TOPIC	Where to look in this manual?
<p>Leaks — plumbing</p> <p>Plumbing leaks can be virtually undetectable, or they can be large enough to cause serious damage in a short period. Turn off the water at various shut-off valves until you can solve the problem. Keep in mind that what looks like a plumbing leak may be leakage from around the edge of a bathtub or shower or condensation on pipes in the walls.</p>	<ul style="list-style-type: none"> • <i>General Information</i>, page 143. • <i>Shut-Off Valves</i>, page 146. • <i>Faucets</i>, page 151. • <i>Bathroom Sinks, Tubs and Shower Enclosures</i>, page 157. • <i>Toilets</i>, page 159. • In this table, see also “Condensation.”
<p>Leaks — roof and ceilings</p> <p>Many things can cause a roof to leak, including damage to roofing materials or flashing, deterioration of caulking, or ice dams.</p>	<ul style="list-style-type: none"> • <i>Roofing</i>, page 58. • <i>Caulking</i>, page 71. • In this table, see also “Condensation.”
<p>Leaks — walls and ceilings</p> <p>Leaks from damaged siding can cause wet areas to appear on walls, but there are other possible sources. Diagnosing the problem is difficult because the wet area may be quite distant from the actual source of water.</p>	<ul style="list-style-type: none"> • <i>Exterior Finish</i>, page 57. • <i>Exhaust Fans</i>, page 136. • In this table, see also “Condensation,” “Leaks — plumbing,” “Leaks — roof” and “Leaks — windows.”
<p>Main beam — sagging or bowing</p> <p>As clay soils expand and contract with changes in weather, the basement floor may rise and fall slightly. In areas with such soils, the posts supporting the beam are made to adjust. In other cases, however, sagging beams and floors may indicate a major structural defect.</p>	<ul style="list-style-type: none"> • <i>Teleposts</i>, page 55. • At the end of this table, see also the note on “Major Structural Defects.”
<p>Molds</p> <p>Molds in the house can affect the health of the occupants. The key to controlling mold is to prevent dampness.</p>	<ul style="list-style-type: none"> • <i>The Environment in Your House</i>, page 17. • In this table, see also “Condensation” and “Leaks.”
<p>No heat</p> <p>Some heating systems shut down automatically if there is any malfunction (e.g., the exhaust system fails). Also, most systems depend on electricity and will not work if the power is interrupted for any reason. Finally, the thermostat may be broken.</p>	<ul style="list-style-type: none"> • <i>Heating System</i>, page 101. • <i>Thermostat</i>, page 134. • <i>General Information</i>, page 169. • In this table, see also “Cold rooms.”

TOPIC	Where to look in this manual?
<p>No hot water</p> <p>An interruption in the flow of power or fuel to your hot water tank can affect the availability of hot water. A low setting on the tank's thermostat or the temporary heavy use of hot water could mean that the tank has been unable to keep up with the demand.</p>	<ul style="list-style-type: none"> • <i>Hot Water Tank</i>, page 148.
<p>Odours — combustion or fuel smells</p> <p>If, by accident, combustion gases are being drawn into the house (backdrafting), you may notice a burning smell. You may also see smoke or feel excessive heat at the air intake of fuel-burning appliances.</p> <p>Unburnt natural gas has a characteristic chemical smell. If you notice such a smell, you may have a gas leak.</p> <p> Backdrafting and natural gas leaks are potentially dangerous, and you should take no chances. If you suspect a gas leak, open windows and doors, leave the house quickly and call your utility or furnace service company, or your municipality, from a neighbour's phone.</p>	<ul style="list-style-type: none"> • <i>The Environment in Your House</i>, page 17. • <i>A Safe and Secure Home</i>, page 26. • <i>Heating System</i>, page 103.
<p>Odours — decay</p> <p>If the smell is coming from the forced air duct system, something may be rotting in a duct.</p>	<ul style="list-style-type: none"> • <i>Forced Air Duct System</i>, page 132.
<p>Odours — sewer like</p> <p>The trap for the basement drain or an unused fixture (e.g., laundry tub may be dry, allowing sewer gas to enter the house. This is easily corrected).</p>	<ul style="list-style-type: none"> • <i>Drains and Traps</i>, page 153.
<p>Odours — stale or damp and musty</p> <p>Inadequate air exchange between the inside and outside of the house, or poor circulation of air within the house, will cause air to stagnate and smell stale. If poor circulation is limited to one part of the house, there may be localized condensation and mold growth in the ducts.</p>	<ul style="list-style-type: none"> • <i>The Environment in Your House</i>, page 17. • <i>Forced Air Duct System</i>, page 132. • <i>Exhaust Fans</i>, page 136. • <i>Heat Recovery Ventilator</i>, page 139. • In this table, see also "Condensation."
<p>Roof damage</p> <p>A severe wind storm can tear shingles loose, even from a new roof. Over the years, roofing material will age and deteriorate.</p>	<ul style="list-style-type: none"> • <i>Roofing</i>, page 58. • In this table, see also "Leaks — roof."

TOPIC	Where to look in this manual?
<p>Smoke from combustion appliance</p>	<ul style="list-style-type: none"> • In this table, see “Odours — combustion or fuel smells.”
<p>Squeaky floors No wood-frame house is completely squeak-free. However, loud squeaking can often be corrected.</p>	<ul style="list-style-type: none"> • <i>The First Year</i>, page 30.
<p>Wood floors — gaps or rippling Minor changes in humidity can cause small expansions and contractions as floorboards shrink or swell.</p>	<ul style="list-style-type: none"> • <i>The First Year</i>, page 30. • <i>Hardwood Floors</i>, page 89. • In this table, see also “Condensation” and “Dry Air.”

Major Structural Defects

If you believe you are dealing with a major structural defect, turn to Part 3 for information on the home warranty plan. Such defects are uncommon in new houses, but when they occur they are usually warranted for a period of from five to seven years, depending on your particular plan. Major structural defects include failures in any load-bearing elements of the house, or any faults that significantly affect the use of your home. A sagging ceiling or floor may alert you to a structural defect, as may doors and windows that are permanently “out of square” (i.e., they do not fit properly in their frames) and major cracks in foundations or drywall.

PART ONE

THE WHOLE HOUSE



THE WHOLE HOUSE — AN OVERVIEW

Your house is a system of connected parts that fit together to make a strong structure and a comfortable living space. The basic structure of a house is made up of the foundation and frame. The envelope is the house's shell, which separates the indoor space from the outside. The finishes and services are those final touches that make your house functional, comfortable and attractive.

The description that follows best fits a typical wood-frame (or steel-frame) house. In some innovative new hybrid housing, the structure, insulation, water and vapour protection, and sometimes even the finishes, are integrated into a single system.

The Foundations

The foundations of a typical house consist of footings and the foundation wall, usually made of concrete. To protect the foundations from frost damage, they are set in below the frost line. (The excavation for the foundation makes room for a basement or crawl space.) Columns, resting on their own footings on the basement floor, support the main beam of the house.

An alternative to the typical foundation system is called “slab-on-grade.” In this type of construction, the house is set on a concrete slab at ground level, and there is no basement.

See *Foundations and Basements*, page 49, for more information and maintenance tips for the foundations.

The Frame

The frame is the skeleton of the house and, like the human skeleton, it supports the body. Following is a description of the typical elements:

- The main beam runs the length of the basement from foundation wall to foundation wall and helps support the floor above. The beam, which is made of steel or wood, is set across two or more posts.
- The floor joists are lengths of lumber laid parallel to each other, and running from the top of the foundation walls to the beam.
- The subfloor, made of sheets of plywood or other wood panel material, is nailed to the top of the floor joists.
- The studs are vertical lengths of lumber that frame the walls.

- Trusses are triangular frames that usually span the outside walls to frame the roof.

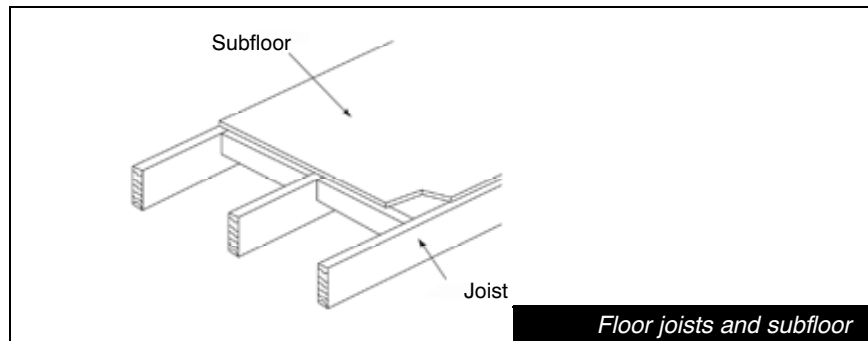

Together, the foundations and the main beam bear the load of the house. Outside walls are built over the foundation wall, inside load-bearing walls over the beam. The basic floor and wall structure is repeated on each ascending floor of the house. The framing is usually strengthened either by wood sheathing fastened to the outside, or by diagonal bracing.

As the frame is generally completely enclosed by other materials (see *The Envelope* below), it does not usually require any maintenance. Therefore, it is not discussed in Part 2 of this manual.

The Envelope

Materials fastened to or held by the framing compose the envelope which, with the framing, make up the walls and roof. Windows and doors also form part of the envelope.

The components of a typical wall might be as follows:

- The exterior finish may be made of siding, stucco, brick or some other cladding.
- Depending on the type of cladding, there may be an airspace just behind the exterior finish, to prevent wind from driving rain right into the house.
- A sheathing of wood or foam insulation panels may be attached to the framing. Water-resistant paper (known variously as the air barrier, wind barrier or building wrap) typically covers the sheathing and helps to shed any water that penetrates the exterior finish. It also protects the insulation.
- Insulation is packed between the wall studs of the frame. As mentioned in the previous paragraph, insulating panels may also be attached to the surface of the framing.
- A vapour retarder prevents moisture from inside the house from moving into the walls, thereby protecting the insulation and structure

from moisture damage. The retarder is usually a plastic sheeting applied to the inside surface of the framing, just behind the drywall or other interior finish; or can be applied as a coating on the drywall. The sheeting may also serve as the air barrier.

In your new house, a lot of work has gone into making the envelope “tight,” which means keeping out the wind, rain and snow and keeping in the heat. As air most commonly leaks at joints between different materials and around window or door openings, caulking and weather-stripping are critical to ensuring a tight envelope.

See *Exterior Finishes*, page 57 and *Doors and Windows*, page 79 for more information and maintenance tips for the envelope.

Interior Finishes

The interior finishes are those attractive, durable surfaces that allow members of the household to live and work in the new house. See *Interior Finishes*, page 87.

Services

The basic services in your house are: *Heating and Ventilation* (page 101), *Plumbing* (page 143), *Electricity* (page 169) and telephones. In addition, some houses have other services, such as *Central Air-conditioning* (page 129), central vacuum, a security system and cable. The framing of the house usually hides the service ducts, pipes and wires.

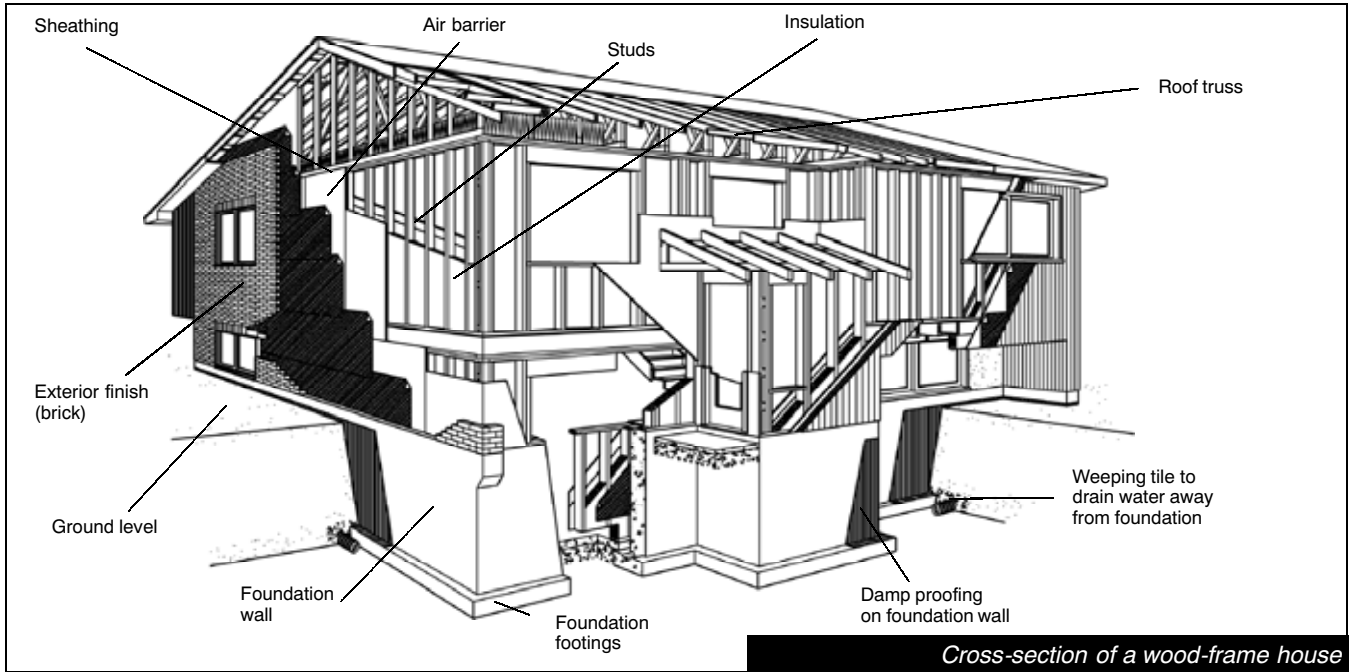

THE ENVIRONMENT IN YOUR HOUSE

By understanding the various factors that affect the indoor environment, you can make sure that your house:

- is comfortable to live in;
- is healthy;
- is economical to heat and cool; and
- stands up well over time.

Three main factors affect the indoor environment: humidity, air quality and temperature. They in turn are controlled by occupant lifestyle and the rate of air exchange (that is, how often stale air in the house is completely replaced by fresh air from the outside). Wind, sun and rain also affect the movement of moisture, air and heat between the inside and outside. This remains true even in new houses, although they are built to allow for careful control of the relationship between the indoors and the outdoors.

The following three sections describe what you can do in your house:

- to control moisture;
- to maintain good air quality; and
- to ensure energy-efficient operation.

Controlling Moisture

Air carries moisture in the form of water vapour. Water vapour moves with the air, and it can also move slowly through many kinds of materials (e.g., wood, cloth or drywall). As warm, humid air cools, its ability to hold moisture decreases. The result is “condensation,” that is, water droplets or ice crystals forming on cool surfaces or in cool spaces (e.g., on windows, or in attics and basements).

Too much condensation in the house is bad. Over time, dampness will damage building materials and finishes, such as insulation, wood and paint. The deterioration of these materials and finishes can give rise, in turn, to a greater release of gases from the materials (off-gassing), which is a potential health hazard. Dampness can also trigger the growth of molds, another source of ill health.

It is important, therefore:

- to watch for signs of humidity;
- to reduce and control humidity;
- to maintain good ventilation and air circulation; and

The Environment in Your House

Outside Air Temperature	Recommended maximum indoor relative humidity at indoor temperature of 21°C (70°F)
-29°C (-20°F)	20%
-24°C (-10°F)	25%
-18°C (0°F)	30%
-12°C (10°F)	35%
-7°C (20°F)	40%

Recommended levels of humidity

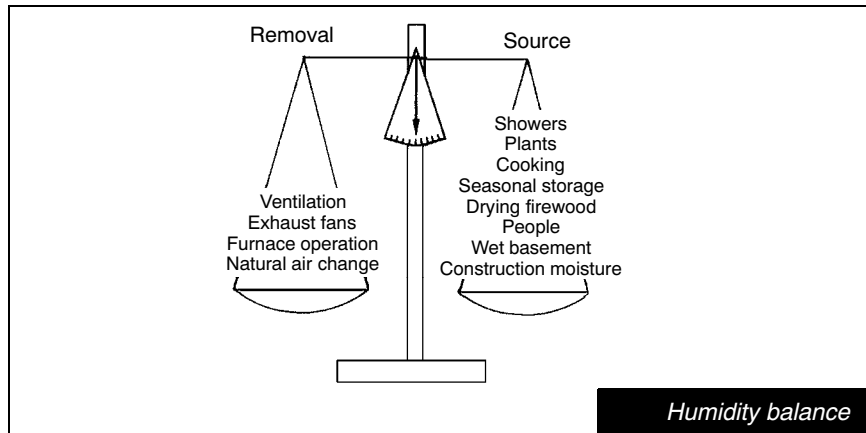

- to clean up dampness whenever it occurs.

Watch for Signs of High Humidity

If you notice any condensation or mold in the house, you probably need to reduce humidity levels.

Condensation: Water or frost on the inside surface of windows is a sure sign of too much humidity in the air (unless it occurs on exceptionally cold days only, and disappears rapidly as the temperature rises). In the bathroom, humidity is likely to condense on the toilet tank, mirrors and walls. In the basement, condensation can occur on walls, floor and pipes.

Mold: Mold commonly thrives on window sills, on the indoor surfaces of exterior walls, and on the grouting between the ceramic tiles in the bathroom. Look in the basement too. Mold grows well in damp, dark corners.

Use a hygrometer — available at any hardware or building supply store — to measure humidity levels. A properly calibrated hygrometer will give you a feel for how humidity varies from room to room over the course of a day and over the length of the heating season. The table shows recommended levels of relative humidity inside the house for a range of outdoor winter temperatures.

Seepage and leaks: Water pooling against the foundation wall can seep into even well built basements or crawl spaces. Leaks in other parts of the house will also add to the moisture load.

Reduce and Control Humidity

When faced with high humidity, the first line of defence is to attack the source of moisture. Here are some key suggestions:

- If you have a clothes dryer, vent it properly to the outside. Do not hang wet clothes in the basement.
- Use the bathroom *Exhaust Fan* (page 136) to remove humidity caused by showering or bathing.

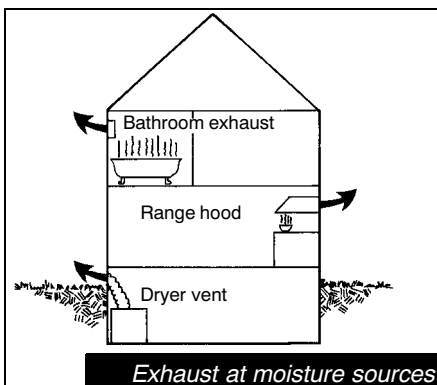

Sources of Moisture in the House

Construction moisture: In the first year to two years after construction, building materials such as wood and concrete dry out and release large quantities of moisture to the air.

Occupant-produced moisture: Many household activities add moisture to the household air — for example, watering plants, drying wet clothes or firewood indoors, showering, using a humidifier and stove-top cooking. Breathing adds moisture too!

Outdoor humidity: Condensation in basements tends to be highest during humid weather in the late spring and early summer, when basement walls and the floor still retain some of their cold-season coolness. As warm, humid air enters the basement from outside, condensation occurs on cool surfaces. Building materials may also absorb moisture during seasonal periods of high humidity: for example, moisture may be absorbed in summer and released in the fall.

- When cooking, keep lids on boiling pots and run the kitchen *Exhaust Fan* (page 136).
- Securely cover any containers of standing water, including sump pits.
- Do not store wet materials, such as firewood, inside your house.
- Use humidifiers only when necessary (in particular, when relative humidity is less than 30 per cent).
- If summertime condensation tends to occur in your basement; keep the windows closed on hot, humid days.
- If your basement is prone to dampness, consider installing a self-defrosting dehumidifier. Run a drainage line directly from the condensate (water) tray to the floor drain, or else remember to empty the tray regularly. The tray should also be cleaned periodically.
- Maintain proper site *Grading and Drainage* (page 41) and keep the *Eavestroughs* (page 69) in good repair, so that water does not pool around the foundations and seep into the basement.
- Quickly repair leaks in the *Roof and Walls* (page 58) and in the *Plumbing* system (page 143).

Maintain Good Ventilation and Air Circulation

Because your new house is solid, with few gaps and cracks, humid indoor air does not readily “escape.” Therefore, you need to ventilate actively, especially in the first two years after construction. Proper ventilation depends largely on the appropriate use of *Exhaust Fans* (page 136). If your house has a *Heat Recovery Ventilator* (page 139), learn how to use it. In spring, summer and fall, opening windows and doors can improve ventilation: however, open windows are not as effective as exhaust fans or a heat recovery ventilator. Also, remember that no kind of ventilation will do much to reduce indoor humidity when the outside humidity is high.

In addition to ventilating, you have to keep air circulating through the house. If you have a forced air heating system, consider setting the

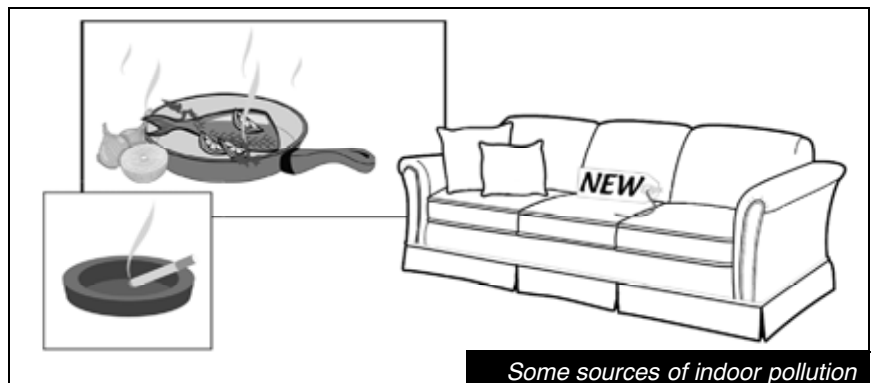

Examples of Alternative Household Products

- Ant and roach traps that use borax mixed with a food attractant.
- Insecticidal soaps, versus chemical sprays, to control insects on house plants.
- Potpourri, made of dried flowers and spices, instead of chemical air fresheners.
- Common household commodities — for example, baking soda, mild detergent and vinegar — for some household cleaning tasks.
- Cleaners, paints and other household products that do not contain strong solvents.

blower fan to operate continuously at low speed (*Heating System and Thermostat*, page 134). If signs of high humidity appear in one part of the house, make sure the warm air grilles are not blocked (see the *Forced Air Duct System*, page 132). Open interior and closet doors and, if necessary, draw back the curtains and move furniture to improve the flow of air into every corner of the house.

Maintaining Air Quality in Your Home

We spend a great deal of time in our houses, and the quality of indoor air is important to our health. To ensure good air quality, you must:

- reduce sources of pollution;
- prevent backdrafting;
- prevent mold growth; and
- maintain good ventilation and air circulation.

Reduce Sources of Pollution

Begin to address pollution through lifestyle choices — for example, by banning cigarette smoking in the house. Also, choose and use chemicals for cleaning or maintenance with care. Here are some tips:

- Avoid aerosol products, such as hair sprays, in the house.
- Avoid using chemical pesticides in and around the house.
- Choose environmentally friendly alternatives to common household chemicals (see box).
- Choose products that bear the logo of Canada's national Environmental Choice Program: many of these pollute less than the chemicals in common use.
- If you have to use a strong-smelling or toxic household chemical, follow directions carefully, and ensure good ventilation.
- Carefully seal all cans and bottles that contain strong chemicals — for example, heavy-duty cleaners and paint solvents — that are not being used, and keep them in a well ventilated place. Ideally, you should store them outside the house, in a safe, well ventilated and dry area that cannot be reached by children. Some chemicals should not be allowed to freeze: keep these in a heated storage area.

Items that are commonly found in a household, such as personal care and cosmetic products, hobby supplies and pets can affect the air quality of your house.

Finishes and furnishings also affect air quality, with different materials emitting gases at different rates — for example, wood emits fewer chemicals than particleboard, and natural-fibre rugs less than synthetic

ones. Given the wide range of materials available to meet any given need, it pays to look for low-emission products. Before bringing new or dry-cleaned rugs, bedding or fabric into the house, air them thoroughly in the outdoors.



Prevent Backdrafting

When exhaust fans or machinery (e.g., a clothes dryer, central vacuum) draw air out of the house more quickly than intake sources can replenish it, they create a kind of vacuum. To compensate, the house may literally suck air down the chimney or backwards through the exhaust systems of combustion appliances (furnaces, fireplaces, wood or gas heating stoves, etc.). If backdrafting occurs during combustion, the house may draw in toxic combustion products along with the outside air.

Backdrafting is not common, especially in new homes; however, because it is dangerous to health, you should know what to do to minimize the risks, and be able to recognize the signs of backdrafting.

The following basic maintenance will minimize the risk of backdrafting:

- Make sure that nothing blocks the air intakes into your house. Label the metal hoods that cover the intakes to make them clearly visible, so they will not be covered by accident (*General Information*, page 101).
- When servicing your *Heating System* (page 101), make sure that the contractor inspects the exhaust system, flue and “fail-safe” controls.
- Periodically clean the chimney of a *Wood Fireplace or Stove* (page 121).

The following signs suggest that backdrafting may be occurring:

- unusual odours from combustion appliances;
- occupants complaining of frequent headaches or nausea; and
- evidence of soot, scorching or melted fittings near air intakes on the furnace or other combustion appliance.

Carbon monoxide, which is produced in badly tuned or malfunctioning combustion appliances, is dangerous when combined with backdrafting. A carbon monoxide detector would warn you of this danger.

If you have a backdrafting problem, contact your builder or a heating and ventilation contractor. Until the problem is corrected, try to avoid conditions that lead to backdrafting. For example, avoid running too many exhaust fans at the same time, and do not use the fireplace if there is backdrafting down the chimney.

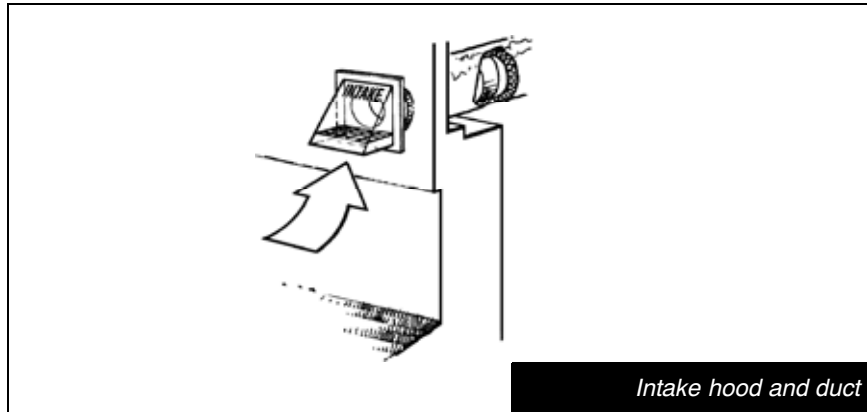

Prevent Mold Growth

Molds (also called mildew or fungi) are tiny organisms that live by breaking down and digesting organic matter. Molds and their microscopic airborne spores can be harmful. Thus, though molds play an essential role in the cycle of life on earth, they do not belong in the house. Molds grow only on wet or damp materials, and they grow best in dark, humid places. They usually appear as a dark “stain” or a fuzzy patch on the wall or ceiling. Often, a musty smell accompanies the appearance of mold.

The key to controlling mold is dryness; so to prevent mold growth, you have to control humidity and water penetration. At the same time, you must ensure good ventilation and air circulation. Advice on these matters is given under the heading *Controlling Moisture*. Here are a few more tips:

- Use a cloth or sponge to wipe condensation off windows and other surfaces as it occurs.
- Keep furniture, curtains and clothing away from cold walls and damp areas.
- In finishing or renovating the basement, consider using a sheet or wood flooring that will not hold moisture or cause condensation against the subfloor.
- Avoid “feeding” molds: keep surfaces dirt- and dust-free.

- Use pure liquid chlorine bleach to clean away mold growth. Before beginning, make sure there is good ventilation and put on rubber gloves. Apply the liquid and let it stand on the moldy patch for 10 to 15 minutes. Then, rinse well with a mixture made of one part bleach to two parts water with some dishwashing liquid added to remove grime and oil. Let the area dry.
- 🌳❤️ Clear vinegar is an environmentally friendly alternative to liquid bleach. Wash the moldy patch vigorously and rinse several times.

Maintain Good Ventilation and Circulation

Ventilation not only minimizes humidity; it also removes unhealthy gases. Good ventilation is always important, but especially during the first year of your house's life, when many building products and finishing materials (e.g., particleboard, carpeting, paints, new draperies and furniture) emit chemicals into the air (off-gassing).

Intake Hood and Duct

- 👤 Never block a fresh air intake or a duct that extends through the wall of your house to the outside. Keep all intakes and outlets clear of snow in winter.
- ❤️ Regularly change the filters in your furnace's air-handling system (*Heating System: Furnace*, page 101) and, if you have one, in your *Heat Recovery Ventilator* (page 139).

Ensuring Energy-efficient Operation

The energy efficiency of any house — even one that is well built and has an efficient heating system — depends on the occupants. Part 2 of this manual offers many energy-conserving tips: these will save you money on your heating bills; often, they will also extend the life of materials and systems. This section presents some key principles, cross-referenced to more details in Part 2:

- Maintain your *Caulking* (page 71) and weather-stripping (*General Information*, page 79).
- Follow recommended procedures for servicing your *Heating System* (page 101) and cleaning or replacing air filters.
- If you have a *Forced Air Duct System* (page 132), efficient heating and cooling depends on a properly balanced system. Refer to the fact sheet for instructions. Also, keep return air grilles and warm air vents clean and free of obstructions.
- If you have a *Heat Recovery Ventilator* (page 139), maintain it well.

- Turn your *Thermostat* (page 134) down at night and whenever you need less heat. A set-back (programmable) thermostat will do this automatically. However, setting the temperature back is not recommended if the house is excessively humid, because cooling surfaces may cause condensation. To reduce that risk, keep the *Heat Recovery Ventilator* (page 139) or the furnace fan (*Heating Systems*, page 101) operating constantly at low speed.
- Reduce the setting of your *Hot Water Tank* (page 148).
- Install water-conserving *Faucets* (page 151) and shower heads that will reduce water consumption, including hot water.
- To reduce the need for air conditioning, plant deciduous trees on the south side of the house (*Landscaping and Vegetation*, page 43) and keep windows and window coverings closed in the heat of the summer day (*General Information*, page 101).
- When buying a major new appliance (i.e., fridge, stove, freezer, dishwasher, clothes washer, clothes dryer), check the EnerGuide rating on the sticker pasted to the appliance. This rating indicates the monthly energy consumption in kilowatt-hours for the particular model. Natural Resources Canada also publishes an *EnerGuide Directory*, rating all models currently on the market.

For More Information

Buying and Using Energy-Efficient Appliances. Natural Resources Canada, M91-10/1-1995E.

Clean-Up Procedures for Mold in Houses. CMHC, 1993, 32 pages, #6753E.

EcoBuyer Catalogue. Environmental Choice Program. Fax: TerraChoice Environmental Services, (613) 247-2228.

EnerGuide Directory of Household Appliances. Natural Resources Canada, M27-103-1997.

How to Improve the Quality of Air in Your Home. CMHC Consumers' Series, 1989, 18 pages, #6177B.

Investigating, Diagnosing and Treating your Damp Basement. CMHC, 1992, 122 pages, #6541E.

Moisture and Air: Problems and Remedies. CMHC Householder's Guide, 1989, 29 pages, NHA 5968.

R-2000: Ventilation and Indoor Air Quality. Natural Resources Canada, M92-81-3-1994.

The Clean Air Guide: How to Identify and Correct Indoor Air Problems in Your Home. CMHC, 1993, 32 pages, # 6695E.



If members of your household are environmentally sensitive, get in touch with the Allergy and Environmental Health Association to learn how to limit their exposure in the home. The Association has branches in several provinces, including British Columbia, Ontario, New Brunswick and Nova Scotia.

A SAFE AND SECURE HOME

Feeling secure in your house depends largely on what you do to prevent, prepare for and respond to emergencies. Security means foreseeing hazards before they turn into real problems. It also means knowing what to do — and being equipped to act — when an emergency arises. Read this section for advice on how to deal with fire, flood, gas leaks or theft. Specifically, this section shows what you can do:

- to prevent serious emergencies;
- to prepare for emergencies; and
- to respond to emergencies in a way that limits risk to life, health and property.

First Steps

1. Keep a list of emergency numbers by the phone and make sure that everyone in the house knows how to reach firefighters, an ambulance and the police. Also list telephone numbers for:
 - household members at work or school;
 - some close neighbours;
 - municipal emergency services;
 - your gas utility;
 - your security company; and
 - your insurance company.
2. As a minimum, keep a fully charged multi-purpose dry chemical fire extinguisher (marked with the symbols A, B and C) in the kitchen. Service or replace it as required.
3. If small children live in the house or visit it regularly, do some basic child-proofing: lock chemicals and medicines away; cover electrical outlets; and block stairs and pools away from children. Keep a well stocked first aid kit in the house.
4. Make sure that all household members know where to find:
 - the main electrical switch (*General Information*, page 169);
 - the main water shut-off; and
 - the shut-offs to various fixtures (*Shut-Off Valves*, page 146).
Tag all system shut-offs, so that they are easily found in an emergency.
5. Leave a spare key with a trusted neighbour or in a secure combination lock box.
6. To help you deal with insurance claims, inventory all valuables in your home, recording the serial and model numbers of portable appliances. Then lodge the inventory in a safe place outside the house.

For More Information

How to Lock Out Crime: Protecting Your Home Against Burglary. CMHC, 1996, 36 pages, #6923E.

Home Care (Fire Safety, pp. 81-86). CMHC, 1985, 116 pages, #5624E.

Cleaning Up Your House after a Flood. CMHC, 1994, 39 pages, #6789E.

Reducing the Risk . . .

. . . Fire

Keep smoke alarms in working order. Test as per manufacturer's instructions.

Use only electrical appliances approved by the Canadian Standards Association or the Underwriters Laboratories of Canada.

Keep appliances and electrical cords in good condition.

Keep chimneys clean and in good condition.

Do not use higher-wattage bulbs than are approved for the fixture.

Avoid storing flammable liquids in or around the house and do not store flammable materials near combustion appliances.

Prevent grease from building up around the stove.

When renovating, maintain required clearances around combustion appliances (e.g., do not install wall-to-wall carpeting right up to the fireplace).

Do not install locks on doors to children's bedrooms and, unless they can be easily released from the inside, on doors to any other occupied rooms.

. . . Flood

Consider installing a backflow preventer (backwater valve) to reduce the risk of flooding from surges in the sewer system. Consult your municipality on whether this is recommended for your area.

Maintain proper site *Grading and Drainage* (page 41). If you have a *Sump System* (page 53), keep it in good working order..

Do not leave the house unheated during a prolonged winter absence. Frozen water can burst pipes and tanks. Turn the heat down but not off. As an extra precaution, you can drain the plumbing system: seek advice on how to do this.

If you vacate the house for an extended period at any time of year, turn off the water supply to the washing machine to

eliminate the risk of flooding if the hose connection should break.

For extra security, turn off the water at the main interior *Shut-off Valve* (page 146): but if you do this, be sure as well to turn off the *Hot Water Tank* (page 148).

. . . Theft

Get to know your neighbours! Join a "Neighbourhood Watch" program.

Secure all windows and doors before going out. If you need to leave a key outside, do not hide it around the house: leave it with a trusted neighbour.

Keep the garage door closed and locked, not only to protect valuables in the garage, but also to prevent a would-be burglar from finding and using a ladder or other tools to break into the house.

When leaving home for a while, try to make the house look occupied. Stop deliveries, ask a neighbour to collect the mail and arrange for someone to shovel the driveway or mow the grass. Leave on an outdoor light and a hallway light inside. Consider installing timers for the lighting system.

Burglars can hide in vegetation, so keep doors and windows clear of shrubbery.

Consider installing a burglar alarm. Consider putting metal bars or some other window guard on basement windows. Position the

bars on the inside of the window and make sure that, while discouraging entry, they do not prevent ready exit.

On request, your local police may inspect your home for security, and advise you on alarm systems.

If you are alone in the house, identify callers before opening the door. Look through the window or peephole, if your door has one, or install a chain guard so that you can safely open the door a little to see who is there.

. . . Gas Leak

If your house uses natural gas, consider installing a gas detector, available at

hardware stores. This device will sound an alarm in case of a gas leak.

. . . Carbon Monoxide (CO)

The incomplete combustion of fuel can produce CO, which is toxic. To ensure proper intake of air for safe combustion, check that nothing blocks the air supply, draft hoods,

exhaust ducts or flues of any combustion appliance. Keep furnace panels and grilles in place when the appliance is operating.

Where required by law, a CO detector will have been installed by the builder. Otherwise, if you have combustion appliances that create a risk, you may install a detector.

Preparing for . . .

. . . Fire

Make sure that everyone in the house knows what to do in case of fire:

Identify escape routes, make sure that all occupants are able to use them, and ensure that the routes are kept clear.

Identify a place outside where household members can gather after escaping the house.

Review these basic fire procedures with all household members:

- Shout "FIRE" and get out of the house quickly.
- If there is smoke, cover nose and mouth with a cloth; then get down close to the floor on hands and knees (smoke rises).
- Before opening a closed door, feel it. If it is hot, do not open it. Find another way out or open a window slightly and call for help.

Place a multi-purpose fire extinguisher (one rated for A-, B- and C-type fires) in the kitchen. Consider installing others in the basement and master bedroom. Show everyone in the household how the extinguishers work. Service or replace fire extinguishers as required (service and expiry dates are usually marked on the extinguisher).

. . . Flood

Find out if your area has ever been flooded and how high the waters rose. If possible, keep valuables above the high-water mark. Store household chemicals in a high place so that, in case of flood, wide-spread contamination will be avoided.

If a flood is pending and time permits, move valuables to the highest spot in the house. If it is not possible to move heavy appliances and furniture, raise them off the floor by placing them on concrete or wooded blocks.

Before evacuating the house, turn off the gas, electricity and water.

Leave a note specifying where you can be reached in the mailbox.

. . . Theft

Use an electrical engraving pen to mark your social insurance number on valuable portable items in your house. Your insurance agent or the local police department may loan out these pens, or they can be purchased at a hardware store.

Your police department may also provide "Operation Identification" decals which, when placed on doors and windows, will discourage burglars.

In addition to a written inventory of valuables in your house, ask your insurance company if photographs or a video are recommended to record jewelry, art or other unique items.

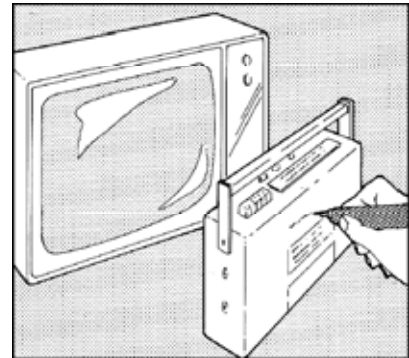

. . . Gas Leak

Natural gas is odourless, but a characteristic odour is added to the fuel to alert you in case of a leak. If you are not familiar with the smell

of gas, your gas utility may be able to send you a "scratch and sniff" card.

Responding to . . .

. . . Fire

Don't panic. Shout "FIRE" to alert everyone, then get out of the house as quickly as possible. Do not dress or retrieve any belongings. Close doors behind you as you leave. Stay close to children and the elderly. Make sure that no-one re-enters the house.

In case of smoke, cover nose and mouth with a cloth. Smoke rises, so get down on hands and knees and stay close to the floor. Feel any door before you open it and, if it is hot, leave it closed. Try to find another way out or open a window slightly and call for help.

Once out of the house, call the fire department from a neighbour's phone.

In the event of a chimney or stove fire, close the fireplace or stove doors and vents, evacuate the house and call the fire department.



For an oil fire (for example, in a fry pan), do not use water! Turn off the stove and cover the pan or close the oven door. Pour baking soda on the fire or use a multi-purpose or B-type fire extinguisher. Do not move a burning pan.

For an electrical fire, unplug the appliance if possible. Then use a multi-purpose fire extinguisher or throw baking soda on the flames. Do not use water: you may get an electric shock.

When using a fire extinguisher, aim at the base of the fire, not into the flames.

If clothes catch fire, do not run. Roll in a rug, coat or blanket to smother the flames.

. . . Flood



Live-powered equipment in a flooded house can cause electric shocks. Do not step into a flooded area if electric outlets (plug-ins) are submerged or if it is possible that electric appliances were left on (e.g., sump pump, electric furnace, electric heater, dehumidifier). If the electric circuit board is

accessible from a dry place, turn off the main electrical switch (*General Information*, page 169).



If a major plumbing leak caused the flood, turn off the water at the fixture shut-off or the main water shut-off valve (*Shut-Off Valves*, page 146).

During a flood, the basement and its contents can soak up a great deal of water. Unless the basement dries out quickly, that water may damage the building and, through the growth of bacteria and mold, affect the health of occupants. Your municipality or insurance company can direct you to a building cleaning and restoration company.

. . . Theft

Do not enter the house if you see that a door or window has been forced or broken.

Call the police from a nearby phone.

. . . Gas Leak

If you smell gas, and if you have a gas stove, gas fireplace or any other gas appliances, check that the gas is turned off.

If you cannot shut off the tanks or appliances, or if these are not apparently the source of the smell, open some windows and doors and leave the house immediately. Call your gas utility or emergency municipal number from a nearby phone.



Do not turn any electrical switches or cause any sparks or flames.

If there are gas tanks sitting outside the house, turn off the gas supply at the shut-offs (located where the supply line to the house leaves the tank).

If your gas comes from a municipal supply line, the shut-off valve is located outside the house, on the gas supply line where it enters the gas meter. Use a wrench to turn the shut-off valve to the "off" position. Do not re-enter the house to get a wrench. (Remember to re light pilot lights once the gas is turned back on.)



A strong gas odour in your yard, street or a nearby excavation could mean a damaged gas pipe or main. Keep out of the area and call your gas utility immediately.



If escaping gas is burning, do not try to put out the flame. Call the fire department.



Some people are extremely sensitive to gas in even the smallest quantities. If you find yourself feeling constantly unwell while at home, consider having the gas checked for leakage.

THE FIRST YEAR

With good maintenance, you can expect many years of problem-free performance from your house. You should be aware, however, that the first year is always a period of adjustment for a new house. During this time, a whole range of minor changes — the most common ones are listed below — occur in most houses. Read on to find what you and your builder can do to help the house settle in. A word of advice: rather than calling your builder whenever a minor problem arises, simply keep track of problems over the first year. Then, toward the end of the one-year warranty period, notify your builder and your home warranty plan in writing of everything that has happened.

This manual will give you a good sense of what is a minor defect or what may be a sign of a problem that can get worse over time. Report signs of potentially big problems early.

Site and Landscaping

Minor ground settlement: As the soil settles around the new house, you may notice slight depressions next to the foundation walls. These depressions should be filled with earth so that rain and meltwater will continue to drain away from the foundations (*Grading and Drainage*, page 41). Your builder may repair significant settlement under the sod during the first year.

Incomplete landscaping: Landscaping work must be timed according to weather and ground conditions, so the builder may not have finished landscaping by your move-in date (*Landscaping and Vegetation*, page 43).

Death of established trees or other vegetation: Grading or servicing of the building lot during construction often disrupts the water table or damages tree roots. Thus, the warranty does not cover vegetation that was on the site before construction, and the homeowner is usually responsible for removing trees and shrubs that do not survive.

Settlement of asphalt driveways: New asphalt will likely show some minor settlement, flaking off of stones, and tire marks. Assuming your driveway has been adequately cared for (*Driveways and Walkways*, page 46), other more significant problems may be covered by warranty.

Foundations and Basements

Cracks in the concrete foundation walls, basement floor and garage floor: In the first few months, concrete goes through a “curing” and drying process, and contraction and expansion may cause minor cracks. Minor soil settlement under the foundations can also cause a little cracking. Small cracks (less than the thickness of a quarter) are not a structural concern, and you can seal them. However, if larger cracks or leaks occur, contact your builder. You should seal a concrete garage floor after the first year to protect it against salt, oil and fuel leaks (*Foundation Walls and Basement or Crawl Space Floor*, page 52; *Garages and Carports*, page 75).

White “dust” on basement walls: As concrete dries, the salts used in making it leech out, leave a residue on the surface. This is normal during the first year, and the white “dust” can usually be removed with water and a brush. If, however, new patches of salt residue continue to appear over the longer term, it may mean that water is seeping through the concrete. This is serious, as water can damage the building and its contents and promote mold growth: you should address the problem. Water pooling around the foundations is a common cause of seepage (*Grading and Drainage*, page 41; *Eavestroughs*, page 69).

Exterior Walls and Roof

Hairline cracks in mortar, stucco or brick joints: Temperature extremes and slight settlement can cause fine cracks to appear in mortar or stucco: such cracks are not usually a cause for concern. Bring larger cracks to the attention of your builder (*Exterior Finishes*, page 57).

Slight gaps in siding: Temperature changes and wood shrinkage can cause small gaps to appear in wooden siding. As long as the siding continues to shed water, such gaps are not usually a problem. However, contact your builder if you see any large gaps or buckling of the siding (*Exterior Finish: Siding*, page 57).

Inside the House

Imperfectly fitting door in its frame: Wood shrinks during the drying-out period and also responds to changes in temperature and humidity. If doors continue to fit badly at the end of the first year, inform your builder. The wood in the door may be warped, or the house may have settled (*Doors*, page 81).

Visible seams in resilient subfloor: Few subfloors are perfectly seamless; however, prominent ridges are not acceptable. The builder may

repair ridges, as well as nail pops and depressions, at the end of the first year.

Wrinkled or buckled carpet: Ridges in the subfloor may cause the carpet to wrinkle; or the carpet may simply need to be restretched or resecured. Notify your builder.

Floor squeaks: The wood-frame structure of the house contains moisture. As the house is lived in, and especially during the first two winter heating seasons, the wood dries out and shrinks and shifts slightly: the result is squeaking. A totally squeak-free wood-frame house is a virtual impossibility; however, excessive squeaking can be fixed. Ask your builder.

Nail pops or hairline cracks in the drywall: The normal drying out and shrinking of lumber, or minor settlement of the house, may push drywall nails or screws out of the wood and cause hairline cracks and other minor defects in the drywall. Truss uplift (a bowing of the roof truss chord) can also cause cracks where the drywall joins at walls and ceilings on the upper floor. A slight bowing is common, and it may be impossible to prevent it completely.

The builder may not be responsible for a small number of isolated nail pops, but will usually repair damaged areas of drywall at the end of the first year. The homeowner usually takes responsibility for repainting or refinishing the walls. As the drywall will probably need minor repairs after the initial period, new homeowners should wait at least two years before redecorating (*Drywall*, page 96).

Minor cracks in woodwork joints; minor gaps between walls and cabinets, vanities, countertops or bathtubs; and minor gaps in wood flooring: Again, the natural movement of lumber as it dries and shrinks causes all kinds of small gaps and cracks. Gaps in flooring may occur on a seasonal basis, appearing in dry winter weather and disappearing in summer (*Hardwood Floors*, page 89). Where cracks or gaps open up around bathtubs or other areas prone to wetness, remove and replace the caulking immediately (*Caulking*, page 71; *Bathroom Sinks, Tubs and Shower Enclosures*, page 157). The builder will normally repair severe cracks or separations at the end of the first year.

Higher levels of condensation: Many construction materials contain moisture and, as they dry out during the first year, they contribute to relatively high indoor humidity. It is important to control indoor humidity (*The Environment in Your House, Controlling Moisture*, page 17).

Unbalanced heating and cooling: After living for a while in the new house, you may realize that some rooms are too hot and others too cool. It is usually possible to rebalance the distribution of heat (or cool air, if you have air conditioning) to suit your needs and preferences. If you have a forced air heating system see *Forced Air Duct System*, page 132.

WARRANTY REMINDER AND MAINTENANCE CALENDAR

Homeowner Warranty Reporting Responsibilities

As the owner of a new house, you can embark on home ownership with confidence; house construction methods now produce superior, reliable products. However, as with all products, things can and do go wrong occasionally. To guard against this eventuality, product and component manufacturers, and the trades people who install them, provide warranties. These differ from one to another manufacturer as to the extent of what they cover. Familiarize yourself with the content of these warranties because you may inadvertently make them invalid by not following the instructions properly.

Similarly, the whole house might also be covered by a warranty. Your builder makes that choice and would normally discuss with you what coverage is included in the purchase agreement.

In both the product and the whole house cases, there are a few things you must do to make sure the warranty will cover you as intended. The table “Homeowner Warranty Reporting Responsibilities” offers a few useful reminders.

Another useful tool is the *Seasonal Maintenance Calendar* (see next page). The information in Part 2 of this manual addresses house maintenance in a comprehensive way. However, some maintenance is especially important. Use the calendar to remind yourself of key maintenance activities throughout the year. Remember that not everything in the calendar is necessarily relevant to your house. For example, if you have electric baseboard heating, instructions related to the furnace do not apply.



If the manufacturer has provided instructions with equipment or materials, read them before starting in on maintenance or repairs.

Warranty and Maintenance

Time	Homeowner Responsibility
Date of Possession (Closing Day)	Conduct a careful pre-delivery inspection of your house, with your builder's representative. On the standard form that your builder supplies, write down anything that is unsatisfactory. Once the form has been filled and signed, the builder will copy and will respond with a plan of action. If you later discover a problem that existed before you took possession, but that you did not list on the form, report it in writing to your builder.
Before the end of Year 1	Most builders and their trades cover a good range of defects in work or materials that are likely to show up within the first year. Notify your builder in writing before the end of the first year. Suggestion: Keep track of minor problems and file a single report close to the year end.
Before the end of Year 2	As well as the first year coverage, your builder may also provide two-year coverage for a small number of problems (e.g., water seepage or leaks or problems affecting the electrical, plumbing and heating systems). You must report the problem in writing to the builder before the end of the second year.
Within 5, 7 or 10 years	Warranty plans cover major structural defects (i.e., faults in materials or workmanship that cause failure of a load-bearing part of the structure or that seriously affect your use of the house) for five, seven, or, in cases, ten years. If major problems arise, notify your builder immediately.

Seasonal Maintenance Calendar

Maintenance Activity	Page	Notes
January / February		
Clean or replace furnace filter.	<i>Heating System</i> , page 103	
Check/clean heat recovery ventilator; wash or replace filter.	<i>Heat Recovery Ventilator</i> , page 139	
Ensure that air intakes, exhausts and meters are clear of snow.	<i>Heating System; Exhaust Fans</i> , page 136; <i>Heat Recovery Ventilator</i> , page 139	
Clean humidifier	<i>Heating System</i> , page 101	
Clean range hood filter	<i>Exhaust Fans</i> , page 136	
Check basement floor drain	<i>Drain and Traps</i> , page 153	
March / April		
Clean or replace furnace filter	<i>Heating System</i> , page 101	
Check/clean heat recovery ventilator; wash or replace filter.	<i>Heat Recovery Ventilator</i> , page 139	
Clean humidifier	<i>Heating System</i> , page 101	
Check sump pump	<i>Sump System</i> , page 53	
Check gutters and downspouts and clean if needed	<i>Eavestroughs</i> , page 69	
Inspect air conditioning; service as needed (usually every two or three years)	<i>Central Air-conditioning</i> , page 129	
Inspect basement or crawl space for signs of seepage/leakage.	<i>Foundation Walls</i> , page 50, <i>Basement or Crawl Space Floor</i> , page 52	
Ensure that ground slopes away from foundation wall.	<i>Grading and Drainage</i> , page 41	
May / June		
Open outside hose connection.	<i>Outside Faucet</i> , page 151	
Clean windows, screens and hardware; install screens	<i>Windows</i> , page 84	
Check that air intake and exhausts are clear of debris, nests, etc.	<i>General Information; Exhaust Fans</i> , page 136	
Clean range hood filter	<i>Exhaust Fans</i> , page 136	
Undertake spring landscape maintenance; fertilize young trees.	<i>Landscaping and Vegetation</i> , page 43	

Warranty and Maintenance

Maintenance Activity	Page	Notes
July / August		
Air out damp basements on <i>dry</i> days or use dehumidifier	<i>The Environment in your House</i> , page 17	
For central air conditioning, clean filter in air handling unit.	<i>Central Air-conditioning</i> , page 129	
Check exterior finishes	<i>Exterior Finish</i> , page 57	
Check exterior wood for deterioration	<i>General Information</i> , page 57	
Check caulking and weather- stripping, including around entry door from garage and house	<i>Caulking</i> , page 71 <i>General Information</i> , page 79.	
Check basement floor drain trap; replenish if needed	<i>Plumbing</i> , page 153	
Have furnace/heating system serviced (every two years for an electric furnace)	<i>Heating System</i> , page 101	
September / October		
Check fireplace and chimney; service or clean if needed	<i>Heating System</i> , page 101	
Clean range hood filter	<i>Exhaust Fans</i> , page 136	
Clean leaves out of eavestroughs	<i>Eavestroughs</i> , page 69	
Check roofing and flashing for signs of wear or damage	<i>Roofing</i> , page 58	
Close outside hose connection	<i>Outside Faucets</i> , page 151	
Close windows, skylights	<i>Windows</i> , page 84	
Winterize landscaping	<i>Landscaping and Vegetation</i> , page 43	
November / December		
Clean or replace furnace filter	<i>Heating System</i> , page 101	
Check or clean heat recovery ventilator; wash or replace filter	<i>Heat Recovery Ventilator</i> , page 139	
Clean humidifier	<i>Heating System</i> , page 101	
Check exhaust fans	<i>Exhaust Fans</i> , page 136	

Annual Maintenance Calendar

Maintenance Activity	Page	Notes
Annually		
Dust or vacuum electric base boards	<i>Electric Base Board Heating</i> , page 120	
Vacuum ducts behind warm air and return air grilles	<i>Forced Air Duct System</i> , page 132	
Test plumbing shut-off valves to ensure they are working	<i>Shut-off valves</i> , page 146	
Test pressure relief valve on hot water tank; drain some water from tank	<i>Hot Water Tank</i> , page 148	
Do safety checks; smoke alarm, fire escape routes, fire extinguisher, door and window locks	<i>A Safe and Secure Home</i> , page 26	
Check and, if needed, oil door hinges	<i>Doors</i> , page 81	
Lubricate garage door motor, chain, etc.	<i>Garage or Carport</i> , page 75	
Check attic for signs of moisture	<i>Roofing</i> , page 58	
Check septic system; clean if needed (usually about every three years)	<i>Septic System or Holding Tank</i> , page 166	
Other (fill in)		
Every 2 to 5 years		
Resurface asphalt driveway	<i>Driveways, Walkways and Paved Patios</i> , page 46	
Check the chimney cap and the caulking between the cap and the chimney	<i>Roofing</i> , page 58	
Recaulk as necessary	<i>Caulking</i> , page 71	
Refinish wood surfaces, including window frames and doors	<i>Exterior Finish: Siding</i> , page 57 <i>General Information</i> , page 79	
Have ducts cleaned if needed (5 years)	<i>Forced Air Duct System</i> , page 132	
Other (fill in)		

Warranty and Maintenance

PART TWO
SITE



GENERAL INFORMATION

Overview

The “site” refers to land that you own and on which your house stands. Key elements of the site are as follows:

- **Boundaries:** Before construction of the house began, your lot was surveyed and “pins” (usually metal bars in the ground) were driven in at all corners of the property. Later, after the foundations were built, the surveyor recorded the position of the house relative to the lot lines and prepared a lot survey plan or surveyor’s certificate. A copy of this should have been included with the legal documents you received when you took possession of your house.



- **Utility Services:** Traditionally, overhead service lines for electricity (hydro), phone and cable television run from a utility pole to each house; however, in new housing subdivisions, these lines are often installed underground (*General Information*, page 169). Unless you have a well, buried municipal water pipes deliver water, and a buried pipe also removes sewage. There is a municipally operated water shut-off at the property line (*General Information; Shut-off Valves*, page 146). Buried pipes may also deliver gas to your property.
- **Easement:** On some lots, public utilities have “easements” which means that the utility has a legal — but limited — right to use your property for service pipes or wires. For example, there may be a

distribution line for electricity on your property; or there may be an easement for its future installation.

- **Site Grading and Drainage:** Your site has been graded (sloped) so that rainwater and snowmelt flow away from the house and the driveway or parking areas, rather than pooling and seeping in around them (*Grading and Drainage*, page 41).
- **Landscaping and Vegetation:** Grass and other plants, trees and shrubs may have been planted on your site to give it a pleasing appearance, to maintain soil quality, and to provide other benefits (*Landscaping and Vegetation*, page 43).
- **Driveways and Walkways:** These are important site features that will benefit from basic care and maintenance (*Driveways and Walkways*, page 46).

Care and Maintenance

If you plan to install fences, hedges or markers of any kind along the site boundary, make sure you keep within your own property lines, as shown on your lot survey plan. Do not rely on survey pins, as they may have been dislodged or buried during construction, or moved during landscaping. Also, do not assume that physical features, such as swales (depressions in the ground) or utility poles, mark the boundaries. If you are uncertain where the lot lines run, call on a qualified land surveyor.



Call before you dig! If you are planning work with mechanical digging equipment — anything from tree planting or installing a fence to building a deck or addition to your house — check with the local utilities first to make sure there are no underground lines in the path of excavation. Most utilities will mark the location of their services at no expense to you.

Builder's or Homeowner's Notes

Type/location of survey pins

Location of gas lines

Other

GRADING AND DRAINAGE

Description

Your site has been graded so that the land slopes slightly away from your house and driveway. This prevents rainwater and snowmelt from pooling against the foundation or driveway; instead, water drains down to municipal storm sewers or ditches, or to parts of the lot where it can seep harmlessly into the soil.

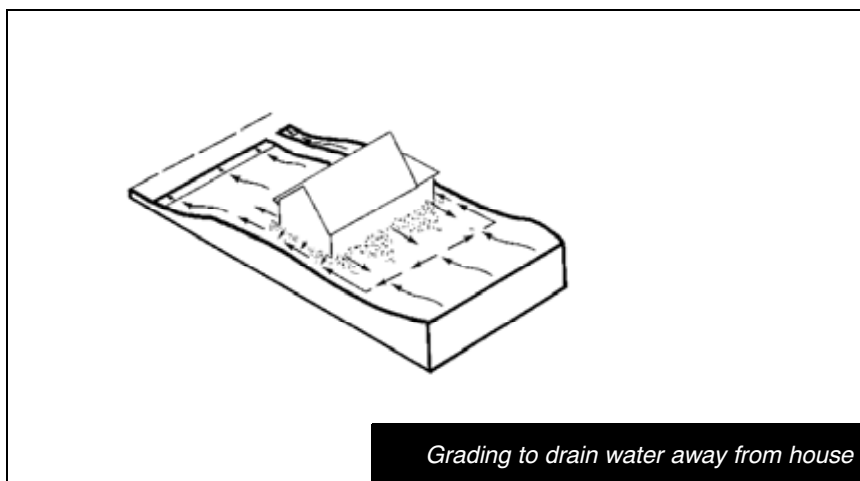

Where the ground had to be built up higher than the basement window level to ensure proper drainage, window wells may have been installed. These wells usually drain to weeping tile (perforated drainage pipes) laid out around the bottom of the foundation.

Swales and catch basins are dug on some sites to control storm flooding and snowmelt. A swale is a shallow valley cut into a slope and used to divert water from around a building. A catch basin is a shallow depression with a sewer grate used to drain rainwater into the municipal sewage system. For steeply sloping sites, terracing — which means breaking a slope into a series of “steps” — supports the slope and minimizes erosion.

Your house may be fitted with gutters and downspouts to direct run-off from the house away from the foundation (*Eavestroughs*, page 69).

Care and Maintenance

Though your builder originally piled soil up beside the foundation to create a correctly sloped grade, settling may have resulted in some low

Grading and Drainage

areas. Shovelling earth into depressions near the foundation will stop water from pooling and seeping in around the foundation. You can “top up” the earth in this way anywhere that soil has settled.

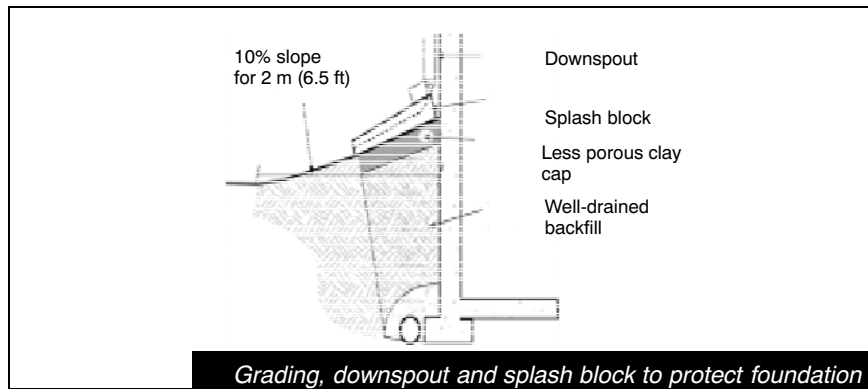

If you have basement window wells, drainage swales or catch basins on your property, keep them free of anything that might interfere with drainage, including leaves or snow and ice build-up.

When landscaping, make sure that water continues to flow in the same direction, away from the house. Also, no matter what changes you make to your own site, remember that you are prohibited under law from blocking the natural flow of water between your land and that of your neighbours, or causing water to be diverted onto their land.

Do not build the soil up any higher than 200 mm (8 in.) below the top of the exposed foundation wall (*Foundation Walls*, page 50). Never cover exterior cladding (e.g., siding, stucco or brick) with soil.

Builder's or Homeowner's Notes

LANDSCAPING AND VEGETATION

Troubleshooting

Burnt grass: Light watering encourages the growth of shallow roots and produces grass that is prone to “burning” in dry spells. Longer watering once or twice a week is better than short daily watering.

Winter kill: Grass and shrubs suffer if the snow above them is packed down (e.g., for a skating rink) or aggressively cleared away. Road salt draining from the driveway can also kill grass and plants.

Additional Tips

The right plants in the right places create a healthy, attractive landscape and reduce the level of work and chemicals needed to keep it green. Things to consider in choosing plants for your site include: sun, wind, rain, traffic and how big the plant will grow. Seek expert advice from your garden centre or a landscaping company.



Many pesticides and herbicides are poisonous and harmful to children, pets, birds and wild animals. Chemical fertilizers in rainwater run-off can overload streams and lakes with nutrients that disrupt the natural balance.

- Go to a gardening centre, library or local environmental group to learn about alternative approaches.
- Choose a lawn care or landscaping company that has an ecologically friendly approach.
- Dig up dandelions, or use a weed stick.

Description

Landscaping — including the planting of lawns and shrubbery — is what turns a raw construction site into a pleasant and habitable property. Landscaping depends on weather and the seasons, and the builder may not have had the necessary time and conditions to finish all the outside work before you moved in. If not, talk to your builder to make sure that landscaping will be completed as soon as conditions permit.

Care and Maintenance

Lawn

To encourage a lush lawn, fertilize the grass as soon as your builder says that it can be walked on without damage. After that, regular fertilizing in spring and fall will help maintain the grass. Purchase lawn fertilizer at any garden centre.

In the first few weeks after sodding or seeding, water the grass every day or two. Once the grass is established, water once or twice a week during dry periods, throughout the summer growing season. Water generously, wetting the soil to a depth of at least 120 mm (5 in.). Water against the house as little as possible. See *Additional Tips* for ways to conserve water.

Once the lawn is established, cut it weekly — but no shorter than 25 mm (2 in.) — with a sharpened lawn mower. In spring, when the lawn is water-logged, stay off the grass. Rake the lawn well in fall.

Trees

Surround every newly planted tree or shrub with a “pit” — a shallow depression of soil about 1 m (3 ft.) wide at the base of the tree — and preserve it for the first two years of a tree’s life: this pit ensures that the roots get enough water during that critical period. Keep tree pits free of weeds and work the top 100 mm (4 in.) of soil periodically to allow air and water to get to the tree roots. Never raise the soil above the base of the trunk. In the spring and summer of the tree’s first year or two, water the tree pit thoroughly once a week; twice a week during hot, dry spells.

Fertilize trees at least once a year, either in early spring or late fall, for the first three to five years. Periodically check young trees for disease

Additional Tips (cont'd)

- Instead of chemicals, use compost, manure and other “natural” fertilizers. These release nutrients slowly, reducing run-off problems.
- 🔪 Some chemical lawn fertilizers contain herbicides.
- 💰👤 Reduce water consumption for your lawn and garden as follows:
 - Water only when there is not enough rain. Water on windless days and in the evening or at night: this is easier on the plants than watering in the heat of the day, and it reduces water lost to evaporation. Instead of sprinkling water high in the air, use drip irrigation (through a perforated hose on the ground) or a sprinkler that delivers large droplets in a fairly flat pattern.
 - Pile grass clippings or wood chips around plants to keep the soil wet.
 - Choose plants that are suited to the natural level of rainfall in your region.
 - Collect water for your garden in rain barrels.
- 💰 On the south side of the house, plant deciduous trees — those that lose their leaves in the fall. These trees will give shade in the summer; and in winter, when the leaves have fallen, they will let in the sun to warm the house. Shade makes a house more comfortable in summer and can reduce the cost of air conditioning by as much as 30 per cent a year! Evergreen shrubs along the north side of your house help to reduce heating costs by breaking the winter wind.

and insect infestation and treat them, if necessary. A garden centre can provide advice and materials. Prune deciduous trees in late winter or early spring before budding starts.

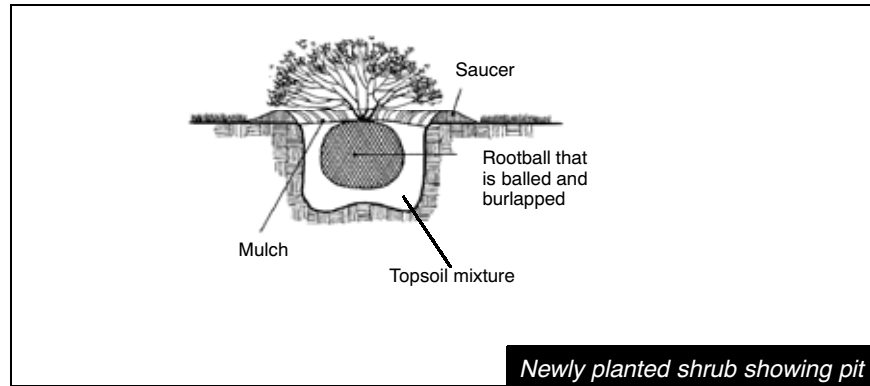

Landscaping next to the house

Keep the earth of raised beds at least 200 mm (8 in.) below the top of the foundation wall. To minimize root damage, interference with drainage and soil settlement, plant trees at least 3 m (10 ft.) from the house and shrubs at least 0.3 m (1 ft.) away.

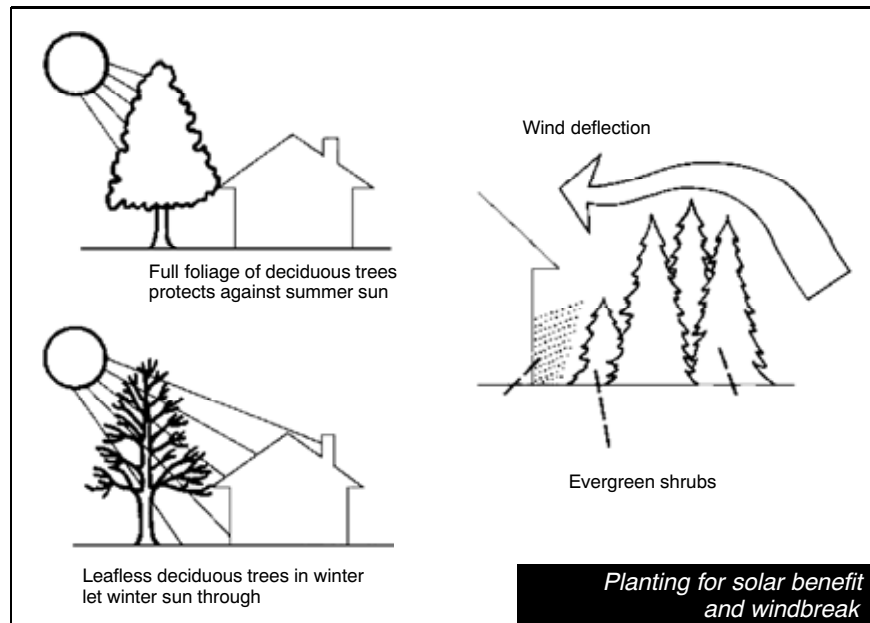

**Additional Tips
(cont'd)**

If there are pet droppings on the lawn, pick them up, place them in a plastic bag and put them in the garbage. If left on your grass, they will cause an unpleasant smell and will eventually disintegrate and join the run-off into storm sewers, which were not designed to handle faeces, or directly into natural streams.

**Builder's or
Homeowner's Notes**

Any special features

Tree or shrub species

DRIVEWAYS, WALKWAYS AND PAVED PATIOS

Troubleshooting

Cracking and heaving: Winter freezing can cause patios, walkways and driveways to crack and lift. This is probably beyond builder's control and, with the return of warm weather, frost-heaved paving stones and other materials often settle back into place. The problem may be caused by too much water soaking into the driveway or walkway, and then freezing. Check that water is not running into the area through improper drainage or roof run-off.

Settling of concrete paving stones: Concrete paving stones lie in a bed of sand or crushed stone. Lift out any pavers that have settled and raise the level underneath them with coarse sand, available at a building supply centre.

Description

Driveways, walkways and patios may be made of:

- asphalt
- preformed concrete slabs
- concrete paving stones (brick paving)
- gravel

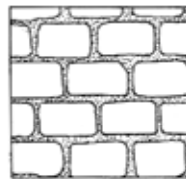

Running bond cobblestone

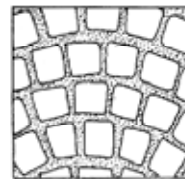

Fish-scale cobblestone



Stacked bond brick pavers

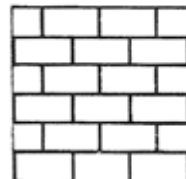

Running bond brick pavers

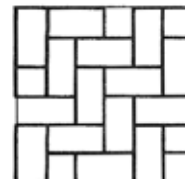

Herringbone brick pavers

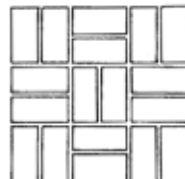

Basketweave brick pavers

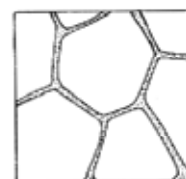

Flagstone

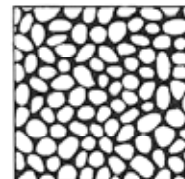

River stone

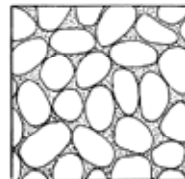

River rock

Some brick paving patterns and other hard-surface treatments

Care and Maintenance

Minor indentations or uneven areas are to be expected on an asphalt drive, as is a little bit of settling under car tires, and dents from sharp objects (especially in hot weather). To minimize damage, remember that your driveway was designed for cars and light trucks. Do not park heavy vehicles on it.

Wash away spilled gasoline and solvents immediately, as they will quickly dissolve asphalt. From time to time during the winter, remove the slush that falls off cars, as the salt in it can harm the driveway surface. Avoid chemical de-icers for the same reason.

Prolong the life of an asphalt driveway by filling cracks; and every two to five years, apply a driveway surface finish. Fillers and roller-applied finishes are available at hardware stores; however, the job can also be contracted out.

- ④ Acrylic sealers are less toxic and last longer than cheaper solvent-based sealers.
- ④ When shovelling snow from driveways and walkways, do not pile it up against the house's air intakes and exhaust outlets (*General Information*, page 101).

**Builder's or
Homeowner's Notes**

Identify driveway, walkway or patio material

Driveways, Walkways and Paved Patios



PART TWO

FOUNDATION AND BASEMENT



GENERAL INFORMATION

Overview

Your house rests on a foundation. The elements that make up that foundation vary, depending on local building conditions and the type and size of house.

Your house, like most in Canada, may be supported by a perimeter foundation, with the *Foundation Wall* (page 50) enclosing a basement or crawl space. Almost always, these walls stand on a “footing,” which is a wide, continuous base that runs under the perimeter of the house.

Concrete or block piers may support decks, porches and any insulated spaces that do not have a basement or crawl space below.

The basement may be a full-height space created by excavation of the foundation. The builder may have “finished” your basement as part of your agreement of purchase and sale. Finishing means that, in order to make the excavated space habitable, the builder applies *Interior Finishes* (page 87) to the floor and walls, and perhaps adds other features, such as partition walls. If your builder did not finish the basement, it can easily be done at a later time.

A crawl space is a partial-height space, usually containing ducts and pipes and, in some cases, a furnace. A crawl space tends to be found in houses where a basement is not needed, or where the foundation excavation was not deep enough to allow for a full basement. Access to the crawl space may be directly from the house, or from the outside, through the foundation wall.

Inside the basement or crawl space are steel, lumber or concrete posts (columns) that support the main beams of the house. These posts, which sit on their own footings, are important structural elements: be careful not to alter them during renovations.

If you live in a region that tends to have clay soils, you may have to occasionally adjust the *Teleposts* (page 55) that support the main beams to keep the beam level.

If you have poor soil conditions or a high water table in your region, a *Sump System* (page 53) will be installed in your basement or crawl space.

Your house may have “slab-on-grade” construction. Instead of having a basement, a slab-on-grade house stands on a concrete slab, which rests on a layer of undisturbed or compacted earth topped with crushed stone at ground level (grade). A *Floor Finish* (page 87) is installed on top of, and hides, the slab. There are no maintenance issues for homeowners. However, noticeable changes to the floor (e.g., buckling or sinking) could indicate settlement problems. Contact your builder.

FOUNDATION WALL

Troubleshooting

Cracks in the foundation wall:

Normal shrinkage in the concrete, and the stress of temperature differences between the inside and outside and between buried and exposed parts of the foundation, cause a certain amount of minor cracking, especially in the first year or two. If these cracks are small and dry, don't worry. However, if you see any bulges in the foundation, or if the cracks are larger than 3 mm (1/8 in.) or appear to be getting wider, you should have them investigated. There are various possible causes. Contact your builder or a structural engineer for assessment and repair.

Cobweb cracks or peeling in the parging coat: Water, if it penetrates the foundation's parging coat, can freeze and damage the concrete finish. Repair the parging coat by removing damaged and loose parging and patching the surface. Proper *Grading and Drainage* (page 41) will help prevent this kind of damage.

Foundation wall exposed below the parging: The soil has settled too much around the foundation. Add enough earth to cover up to the finish.

Seepage and leaks through the foundation wall: There are many possible causes:

- Poor grading may be causing water to pool against the house (*Grading and Drainage*, page 41).
- Run-off water from the roof may be discharging at the foundation (*Eavestroughs*, page 69).
- The foundation drainage system may be blocked, in which case you will need to dig it out. Call a professional to inspect and advise.
- If the water table is high, you may need a *Sump System*, page 53.

Description

The foundation wall is the perimeter wall that encloses your basement. It supports the weight of the house and holds back the earth outside it. The foundation wall of your house consists of **poured concrete, concrete block or pressure-treated wood (PTW)**.

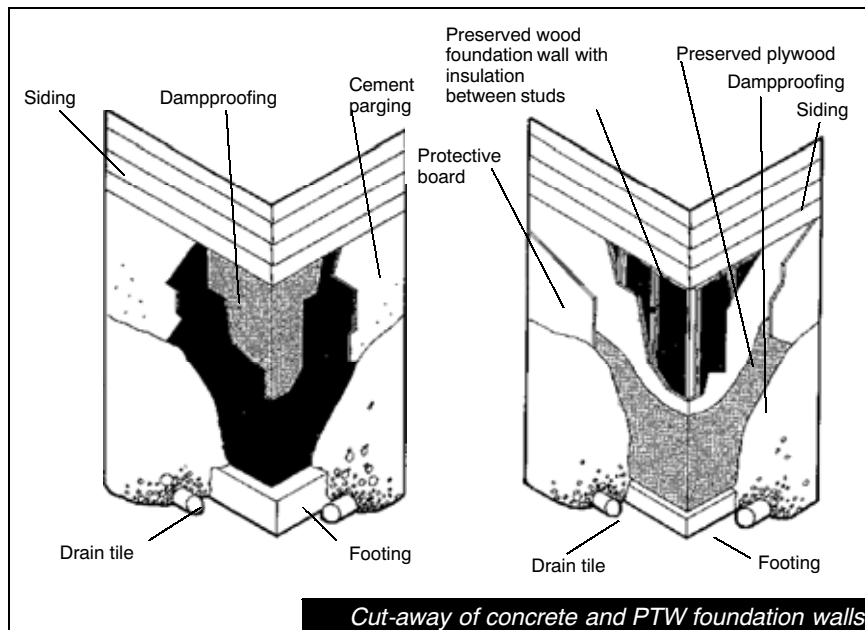

If your foundation wall consists of **poured concrete or concrete block**, it rests on a **concrete footing**. The footing, which spreads the full weight of the house out over the ground, rests on firm soil or gravel below the frost line, or on bed-rock.

Your foundation rests on a **gravel bed**, rather than on footings if you have a **pressure-treated wood (PTW)** foundation wall.

Your foundation wall is insulated to reduce heat loss, to make the basement more comfortable and to reduce the risk of condensation on inside walls. The insulation may be attached to the outside or the inside of the wall.

In order to prevent water from seeping into the basement and damaging the foundations, the builder commonly protects the perimeter of the house as follows:

- Weeping tile is laid out along the footing all around the house, and usually connects to the storm water system. Weeping tile (also

**Troubleshooting
Cont'd.**

Summertime condensation on basement walls or other cold surfaces: Because the earth around the foundation warms up more slowly than the air, condensation is likely to occur on relatively cool surfaces during warm humid weather. Condensation can cause a lot of damage and contribute to the growth of mold. Try to reduce humidity in the house (*The Environment in Your House*, page 17).

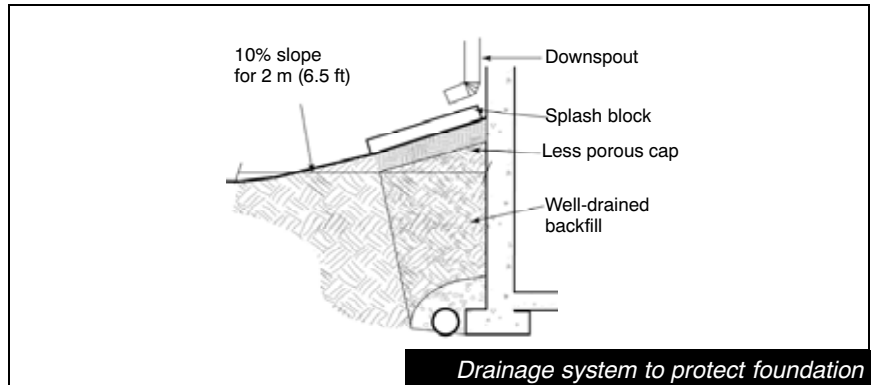

known as drain tile) is simply plastic tubing pierced with holes. Water seeps into the tube through the holes and is carried away to the storm sewers, or at least away from the house.

- A porous “backfill” material, such as gravel, is used to fill the excavation hole around the foundation. Because this material is porous, water drains easily through it to the weeping tile.
- On top of the backfill, slower draining earth slopes away from the house (*Grading and Drainage*, page 41). This surface sheds most rainwater away from the house, rather than allowing it to be absorbed into the ground beside the foundation.
- Below grade (ground level), damp-proofing or a plastic drainage layer is placed over the foundation wall to keep water from soaking into the concrete. The part of the foundation that is visible above ground level is usually parged (i.e., coated with water-resistant cement finish). This finish, which has a stucco-like appearance, protects the foundation wall. To allow for some settlement of earth around the foundations, the finish usually continues a few inches below ground level.

Care and Maintenance

To prevent damage to the foundation wall and leakage into the basement, you must maintain proper drainage and grading (i.e., keep the earth sloping away from the house). Also, when landscaping, keep the soil at least 200 mm (8 in.) from the top of the foundation wall: this reduces the risk of water damage to the siding, insulation and framing of the wall.

As water moves through concrete, salts are leached out and appear on the surface as a white “dust.” This is normal during the first year or so of the house’s life, when the concrete is drying out. Use water and a stiff brush to remove the white deposit. However, if new deposits go on forming after the first year, or if they tend to concentrate in one area, moisture may be affecting the foundation wall. Contact your builder or seek other expert advice.

BASEMENT OR CRAWL SPACE FLOOR

Troubleshooting

Cracks in the concrete: Small, dry cracks are common in concrete floor slabs, especially in the first year or two. Don't worry. Normal shrinkage in the concrete accounts for these minor flaws. However, cracks that are 3 mm (1/8 in.) or more, or that are visibly getting larger, may result from settlement. Call on your builder or a structural engineer for assessment and repair.

Sagging or softness in pressure-treated wooden floors: Moisture may be damaging the subfloor, and you should look for the source (*Foundation Wall*, page 50). Contact your builder or seek professional advice.

Description

Floor Type

- Your basement floor may consist of a concrete slab that was poured on a prepared base, usually of crushed stone or gravel, with a vapour retarder (a heavy plastic sheet) directly under the slab. Often, plumbing drainage lines (*General Information*, page 143) are buried in the slab. If there is a *Floor Finish* (page 87), such as hardwood or resilient flooring, it may be fixed to a wooden subfloor on top of the slab.
- Your basement floor may consist of a pressure-treated wooden frame (floor joists), with wood panel sheathing on top. The joists rest on blocks over a drainage layer of crushed stone. A *Floor Finish* (page 87) may be fixed to this subfloor.
- A moisture barrier (a heavy plastic sheet) covers the ground if you have a crawl space, keeping moisture from entering the house and damaging the wooden structure. A protective covering of sand, gravel, concrete or other material lies on top of this sheet.

Drainage

- Water drained by the weeping tile (*Foundation Wall*, page 50) flows to the municipal storm sewer.
- Your basement floor may have a *Sump System*, page 53. This lowers the level of the water table and keeps water out of the basement.

Care and Maintenance

Do not expect a perfectly smooth concrete floor slab. Some roughness in the texture and some hairline cracks are normal.

During the first year, the concrete is “curing” (i.e., drying out). Wait a couple of years, if you can, to paint the basement floor. If you must paint during the first year, use a primer with a concrete conditioning compound that lets the curing continue.

When storing goods in the basement — especially absorbent materials, such as paper, wood, clothes and upholstered furniture — raise them off the floor and keep them away from the walls. By doing so you are promoting a good flow of air and preventing the growth of mold. Also, in case of flood, you may have reduced damage. When you enter the crawl space under your house, be careful not to damage the plastic moisture barrier.

SUMP SYSTEM

Troubleshooting

Flooding: Assuming that the pump is working, ice may have blocked the discharge pipe. Turn off the pump and disconnect the discharge pipe at the pump. Set up a temporary system of pipes to move water from the pump to the basement floor drain or directly to the outside. Then restart the pump. Have the pipe serviced to prevent it from freezing again.

Debris in the pit: The lining of the sump pit may be cracked or deteriorating. Address this problem immediately, before debris clogs the pump.

Additional Tips

If your sump runs a lot at some times of year, or if you simply cannot afford to have it break down, keep a spare pump on hand. They are not expensive. Install the second pump with its float set higher than that of the first pump: the back-up will take over automatically if the first pump fails.

The pump is powered by electricity, and power failure will put it out of commission. Consider purchasing a battery-powered back-up pump.

Description

Your house has a sump system, which removes storm and ground water from the earth around the foundation, thus preventing floods in the basement or crawl space. The sump system consists of: a pit; a drainage system that directs water into the pit; a pump, if required (some pits drain by gravity); and a discharge pipe. The sump pit, where water from the surrounding soil and rock collects, is usually lined with concrete or plastic and is sunk below the level of the basement floor. The pit's tight-fitting cover prevents accidents and keeps out soil gases.

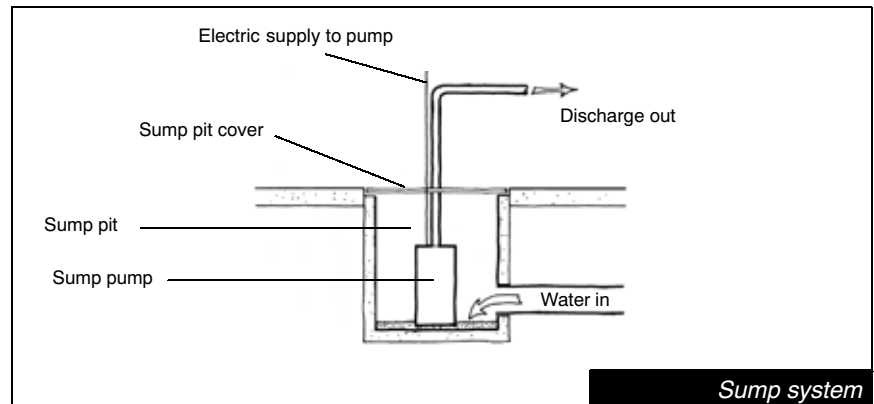

The sump pump has a float (sometimes two), which rises with the water level in the pit; when the float reaches a set height, it triggers an electrically powered pump. The water then pumps out of the pit through the discharge pipe. Check what kind of sump pump you have:

- a submersible type, located inside the sump pit;
- a pedestal type, with the pump motor above the pit, and the pump suction head at its bottom.

Sump water is released through the discharge pipe to the storm water sewer, directly to the outside, or to a dry well.

Operation and Maintenance

Check the sump pump every few months to make sure it is in working order. In particular, check it after a heavy rain and before going away for an extended period. To test the sump pump, remove the pit cover and add a few gallons of water. The pump should start. Also, check that the pipes leading from the pump to the discharge are not bent, crimped or

Sump System

cracked. When finished your inspection, put the cover back on and reseal it tightly.

Inspect, clean and oil the pump once a year, following the directions in the manufacturer's manual. The float that controls the on-off switching of the pump may occasionally need to be adjusted or replaced: with the help of the manual, this is easy to do. Make sure the float is untangled and free of debris.

Your sump pump may drain to an unburied outside hose that attaches to the discharge pipe at the foundation wall. This hose, if it freezes, may crack and damage the pump, and it should be disconnected before winter. Put a splash pad (a concrete paver will do) under the outlet to protect the soil and foundations (*Foundation Wall*, page 50) from water that may drain from the pipe before the hose is reconnected in spring.



Never leave the sump pit uncovered and make sure that children cannot open the cover.

Builder's or Homeowner's Notes

Type/location of sump pump

TELEPOSTS

Troubleshooting

A gap at the joint of wall and ceiling on the top floor: Such gaps generally result from truss uplift, not foundation settlement (*Drywall*, page 96). Do not try to close such gaps by tightening the teleposts.

Additional Tips

If renovating the basement, do not replace teleposts with non-adjustable posts or cover up the adjustment mechanism. When building partition walls in the basement, remember that the clay soils in your region will cause periodic lifting and falling of the slab. Get expert advice on how to accommodate that up and down movement by framing walls short of the floor, and attaching and supporting them from the top.

Description

Teleposts are adjustable steel columns that stand in the basement or crawl space of your house and support the main beam. Teleposts have a threaded screw that permits changing the height of the top plate (where the main beam sits). Because teleposts are adjustable, they can be set to keep the main beam level, even when the soil or structure is shifting slightly. This is particularly important for your house, which is in a region of clay soils. These soils tend to swell and shrink as the moisture content changes. When soils swell, the floor may lift and the teleposts push up the main beam: such movement puts stress on the whole structure.

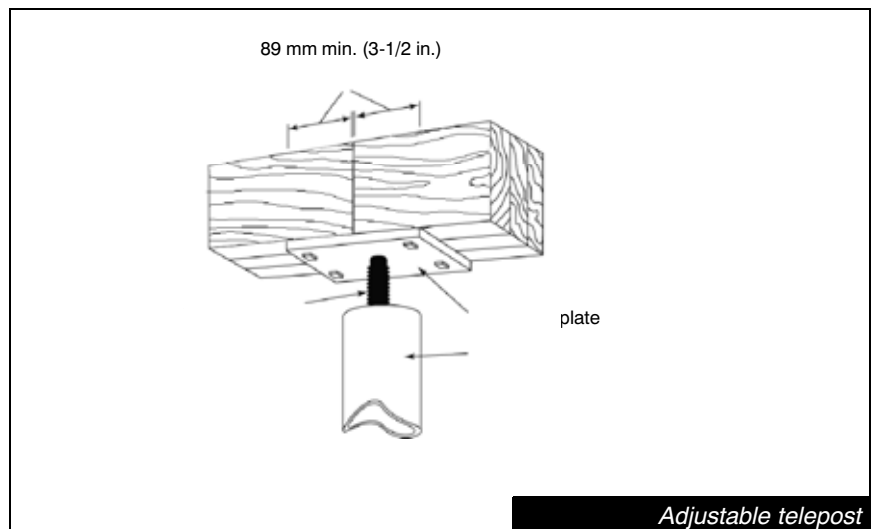

Operation and Maintenance

Check every two to four months to see whether the beam has lifted or settled at the teleposts. A thick string or cord stretched tight beside the beam will show any bowing or sagging. If you have to adjust the teleposts, do it slowly to give the structure time to adapt: turn the screws no more than $\frac{1}{4}$ turn a day. Do not over-raise the post. To get more power when tightening, slide a strong metal or plastic tube, 45 to 60 mm (18 to 24 in.) long, over the handle of the pipe wrench.

Teleposts

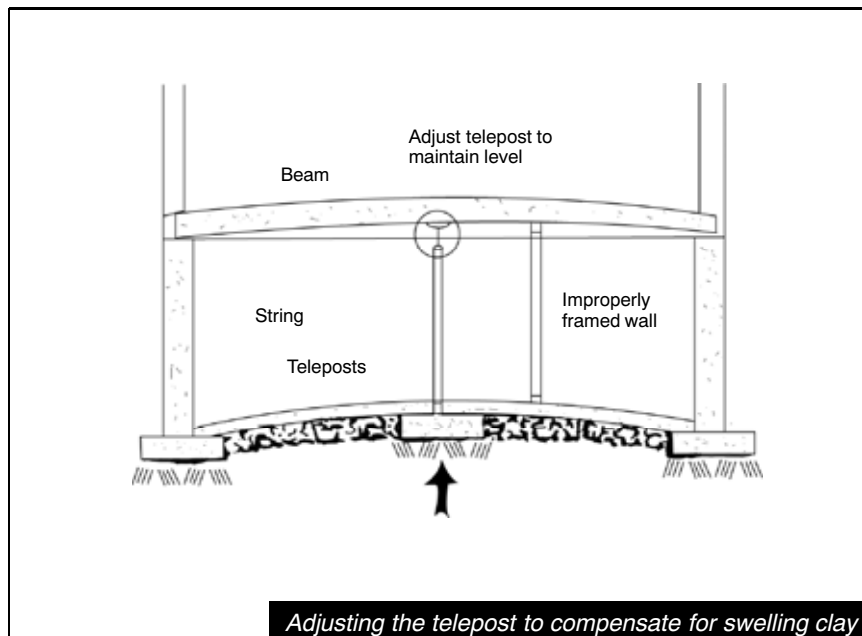

Adjusting the telepost to compensate for swelling clay

Builder's or Homeowner's Notes

Note to the builder: This applies only to regions where clay soils may require owners to adjust teleposts.

PART TWO

ROOF, OUTSIDE WALLS AND OTHER EXTERIOR FEATURES



GENERAL INFORMATION

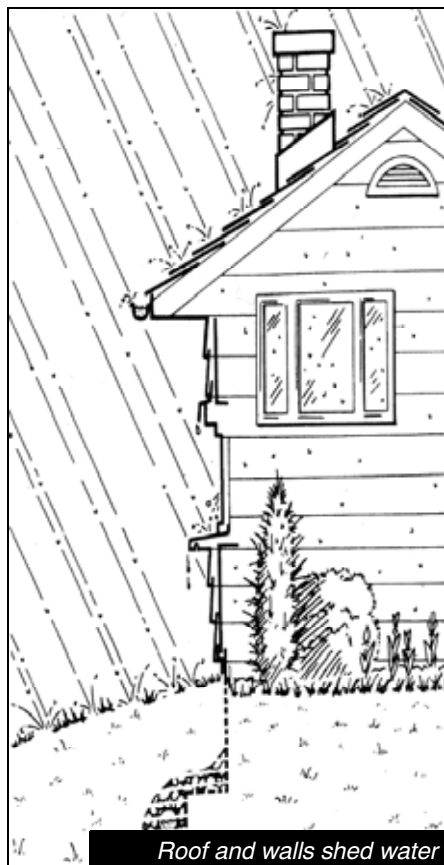

Overview

The roof and outside walls give your house structure and protect your home from rain, snow, wind and sun. They also secure the house against intruders.

A variety of cladding materials can be used to form the *Exterior Finish* on the outside walls. The most common materials are siding (wood, metal, vinyl or fibreboard), masonry (brick or stone) and stucco. Wood is often used for trim and other exterior detailing, such as railings and columns. Caulking at joints and along openings on the roof and in the outside walls makes the structure weather tight. Eavestroughs at the edge of your roof guide the water from the roof away from the foundations. Other exterior elements are *Stairs, Porches and Decks* and *Garages and Carports*.

Though the homeowner has to maintain only the exterior finishes and interior finishes of the outside walls, some understanding of what lies between these finishes is useful. See *The Whole House, An Overview* (page 13) for a description of a typical wall system. Doors, windows and other openings (e.g., holes made for ventilation hoods and utility pipes) are also part of the outside walls (*Doors and Windows*, page 79).

Maintenance

The exterior of your house was designed and built to be attractive and durable with as little maintenance as possible. However, you cannot afford to neglect this part of the house if you want to avoid problems and save money. Get into the habit of following a basic maintenance regime, and once or twice a year check over the exterior of the house, keeping a specially close watch on potential trouble spots.

Keep the caulking in good repair and act quickly if there are signs that moisture is getting in through the roof or walls. In addition to actual leaks, signs of water penetration include a marked deterioration, staining or warping of materials.

Never cover the exterior wall finish with soil and avoid building new structures (e.g., a deck or porch) directly up against the finish, especially if there is any risk of water penetration or snow build-up.

ROOF

Troubleshooting

Leaking roof: Many things can cause a roof to leak. Consult your builder or a roofing expert for assistance in identifying and repairing roof leaks. Common causes of trouble are:

- Ice damming:** This occurs when snow melts on the roof. If the water run-off freezes at the edge of the roof, ice may gradually build up there to form a “dam.” If enough water pools behind that dam, it may eventually seep under the roofing material. If the roof leaks, you must remove the ice, but carefully, so as not to damage the roofing. In a new house, ice damming is likely to occur only when rain falls on a heavy accumulation of snow, but can also occur under other sets of conditions. If ice damming occurs under other conditions, it may indicate roof ventilation or insulation problems, or major air leakage between the house and the attic. If air flows freely between the insulation and the underside of the roof sheathing, ice damming may be alleviated but not prevented. For help in locating air leaks and fixing them, see the advice given under *Leakage caused by condensation*. If the problem persists, contact your builder or a roofing contractor.
- Damage to roofing:** A severe storm can damage a roof. See the section on *Care and Maintenance*.
- Damage to flashing:** Flashing around the chimney is particularly vulnerable. Patch tears or gaps temporarily with plastic roof cement or, even better, with polyurethane caulking, which lasts longer. Even with repairs, however, the flashing will deteriorate over time and will eventually need replacing: that is a job best left to a professional roofer.

Description

There are two basic types of roofs: ventilated roofs and insulated roofs.

Ventilated roof: This kind of roof has an open space between the insulation (on top of the upper floor’s ceiling) and the roof peak. Vents placed low on the rooftop or in the soffits allow air to flow into the open roof space, then to pass out through vents at the roof-top ridge or in the gables (the triangular-shaped section of wall at either end of the roof). This ventilation helps to keep the attic relatively cool in summer; in winter, it reduces moisture build-up in the attic and prevents ice damming on top of the roof. This roof ventilation is completely separate from the ventilation of the house itself.

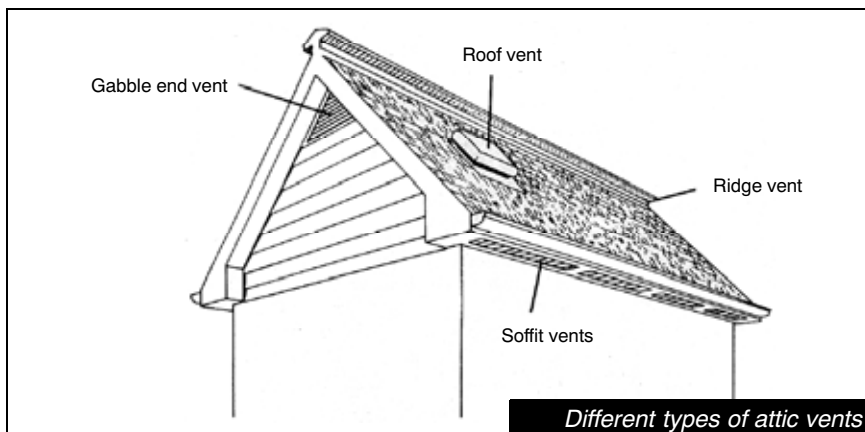
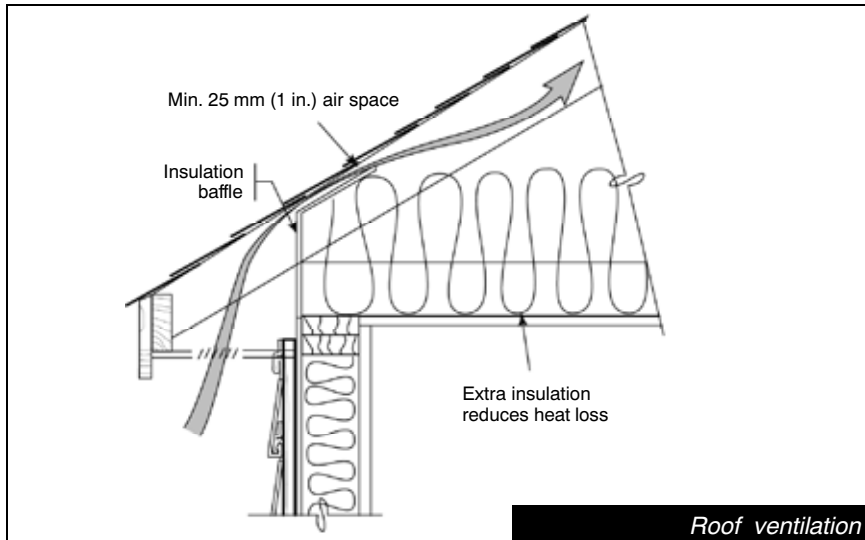

**Troubleshooting
Cont'd.**

Leakage caused by condensation:

If the roof is sound but water is seeping through the ceiling, the problem may be condensation in the attic. Frost on the underside of the roof is a sign that condensation is occurring. Condensation occurs when warm, moist air from inside the house moves through the ceiling into the cool attic space. Condensation may cause a build-up of ice during long periods of sub-zero weather; then during thaws, the ice in the attic melts and leaks into the house.

As a general response, and especially if there are other signs of excess humidity in the house, try to reduce humidity (*The Environment in Your House*, page 17). More specifically, if indoor air is leaking into the attic, you must find the leaks and seal them.

Before consulting your builder or a roofing expert, check the following possibilities:

- An attic access hatch, if dislodged, will allow warm air into the attic. Check periodically that the foam weatherstripping around the attic access hatch is still resilient. Do not paint over the foam and, whenever you use the hatch, make sure that it closes tightly behind you and that it sits over the foam with no gaps (*General Information*, page 79).
- Check the ducts from bathroom *Exhaust Fans* (page 136). If these pass through the attic, they should be insulated and firmly fitted at the point of exit. Make sure that the exhaust louvres (flaps) open when the fan is on, and close when it is off. Remove ice or anything else that is blocking the ducts. Also, make sure that there is no other source (e.g., plumbing vents, chimneys) of warm, moist air leaking into the attic.

☞ In the first winter after construction, the large amount of moisture in new materials makes for a relatively high risk of condensation in the attic.

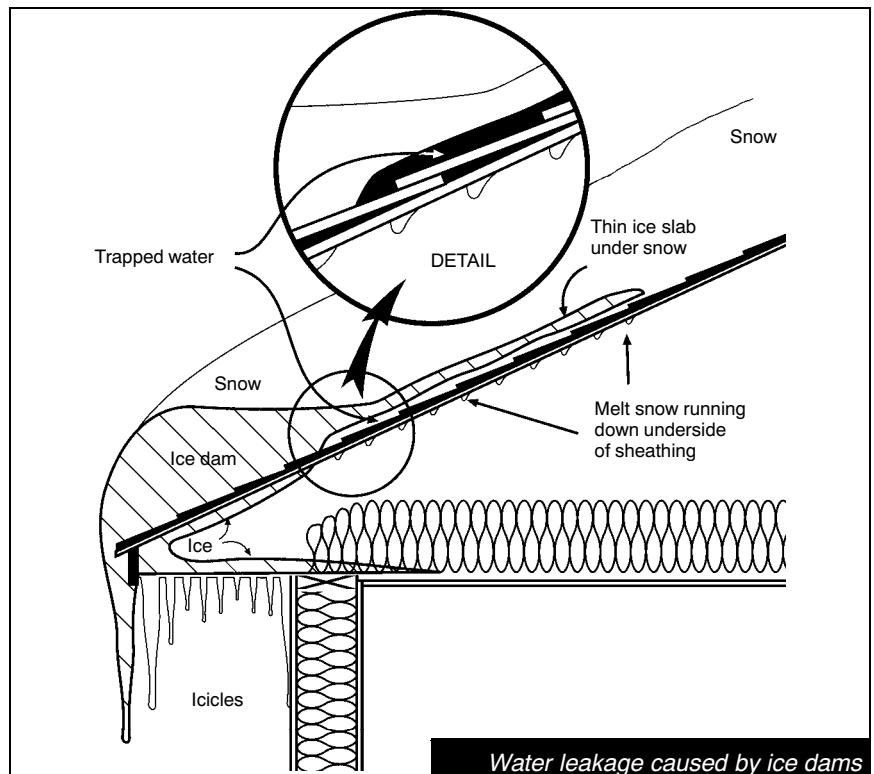

Insulated roof, either flat or cathedral: An insulated roof is often used where the wooden roof beams (joists) are exposed on the inside. Insulated roofs are often found, for example, over balconies and decks.

The most commonly used roof coverings (roofing materials) are: **asphalt shingles, wood shingles, rigid roof tiles, metal or gravel.**

On flat or low-pitched areas of the roof, the roof covering may be **asphalt sheet or rubberized sheet.**

Roof coverings normally last many years without needing to be repaired or replaced. Slight colour variations occur during the manufacture of roofing materials, and this may not be within the builder's control; however, such variations are hardly noticeable — and they become less so with time — and do not affect roof performance.

Additional waterproof materials are built into the roof at especially vulnerable points:

Flashing: usually made of sheet metal, with a factory — applied colour — lines the junctions (valleys) where two roof sections meet or where a dormer window interrupts the lines of the roof. Flashing is also used to cover seams where certain elements penetrate the roof, such as attic vents, chimneys, plumbing vent pipes (*General Information*, page 143), bathroom exhaust ducts (*Exhaust Fans*, page 136) and skylights.

- The eaves are part of the roof that project beyond the walls of the house, and they are especially vulnerable to snow and ice build-ups.

Additional Tips

Do not walk on asphalt roofs on hot days. Heat softens the shingles, and you may easily damage the protective surface.

When installing antennae or other equipment on the roof, make sure that neither the installation process, nor the method used to attach the equipment, damages the roof.

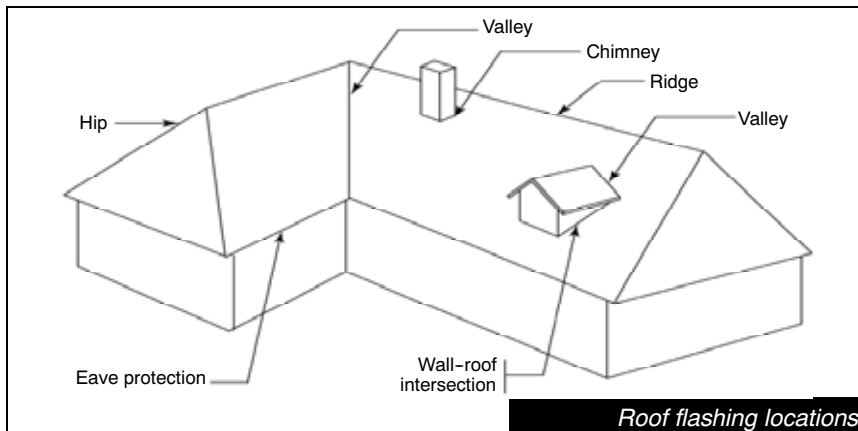

Eaves protection — which takes the form of asphalt-impregnated paper, rubber sheeting or some other water-resistant material — is usually applied under the roofing material at these overhanging edges, and it helps to prevent ice dams from forming.

- The metal or concrete cap at the top of the chimney sheds snow and rain.

The underside of the eaves is called the soffit; the front edge is called the fascia. Your soffits and fascia can be made of wood or metal (aluminium or steel).

Care and Maintenance

Be careful. Working on a roof is dangerous. Make sure your ladder is in good repair and position it solidly so that it extends 1 m (3 ft.) above the roof edge. Wear footwear that grips well. Do not go on the roof when it is wet, snowy, or icy, or when strong winds are blowing.

After a heavy windstorm, check for loose, broken or missing roof shingles. Wind-related damage is not the builder's responsibility, but your homeowner insurance policy may cover it. Before going up on the roof, scan it with binoculars to see if further investigation is necessary. If repairs are needed, do them right away to prevent damage to the house. Unless you have experience in repairing roofing, call a roofer.

After a period of snow and severe winds, check the attic to see if any snow has blown in through the vents. If so, remove it.

- 🔪 When working in the attic, avoid damaging the ceiling below you. Keep your feet on the framing (the joists or trusses) or lay boards on the insulation to distribute your weight.

After an unusually heavy build-up of snow, you can lessen the risk of structural or water damage by shovelling snow off the roof. Do not shovel right down to the roofing material: leave a few inches of snow.

Part Two — Roof, Outside Walls, and Other Exterior Features

Over time, roofing material will wear out. Because of the ultraviolet radiation from the sun, a south-facing roof usually weathers more quickly. Keep an eye out for signs of deterioration. For asphalt shingles, such signs include: mineral granules eroding from shingles and collecting in the gutters; curling at the edges of the shingles; and cracked or punctured shingles. Depending on the particular shingles, they have a life of between 15 and 30 years.

Every five years, check the chimney cap and the caulking between the cap and the chimney for signs of significant deterioration or damage. Replace the cap and the caulking, if needed.

Builder's or Homeowner's Notes

Information on warranties for roofing materials

EXTERIOR FINISH: WOOD SIDING AND WOOD TRIM

Troubleshooting

Damaged or deformed siding:

Remove and replace a damaged piece of siding or trim. Consult a home repair manual for guidance, or call your builder or a contractor for assistance.

Cracks, discolouration or other signs of premature deterioration in siding:

Leaks in the siding can cause premature deterioration. Check the *Caulking* (page 71) and, if necessary, replace it. Also, check the siding for cracks — caulking them as you go — and look for other signs of deterioration. Water splashing up on the siding can also cause deterioration. Make sure that no water is pooling against the foundation (*Grading and Drainage*, page 41; *Eavestroughs*, page 69). Often, you can reduce splashing by choosing an appropriate ground surface material (e.g., grass or rounded stones) or by installing eavestroughs or deflectors that direct roof water away from the side of the house.

If the cause of the problem is still unclear, or if the repairs within your scope have not corrected the situation, then contact your builder or a building contractor. Never let water-related problems go, as moisture can cause a lot of damage.

Visible cracks in caulking: As the *Caulking* (page 71) ages, you must replace it.

“Knots” in the wood showing through the finish: Resin seeping out of knotholes will discolour paint. Apply a purpose-made sealer, available at hardware stores, to prevent future resin staining at knotholes, then repaint.

Description

Siding on the exterior of a house can be made of wood or cedar shingles or shakes.

The wood trim on the exterior of a house can include railings, columns or exterior doors.

Care and Maintenance

To clean wood siding, lightly scrub any obviously dirty areas first, using a long-handled brush and a mild, non-abrasive detergent. Then hose the siding gently. Do not use a high-pressure stream, as this may force water through the siding.

If you have the matching paint on hand, you can easily do minor touch-ups to wood siding or trim, or the builder may do this for you at the end of the first warranty period. Be warned, however: colours fade with time, and a perfect match between old and new paint or siding is rarely possible, even if the colours come from the same batch. If you buy new paint or siding, it is bound to be slightly different in colour than the original lot. Builders will generally not repaint the whole house or large areas in order to match colours perfectly.

Standard painted wood siding will last about five years before needing a new coat, depending on the colour and quality of the paint, as well as degree of exposure to rain and sun. A wood siding that is factory-painted should keep its finish for at least ten years. Plan to repaint the siding whenever the paint begins to discolour and flake off. You may have to restrain or reseal unpainted siding relatively more frequently.

 Choose a dry day for painting, when temperatures of over 10°C (50°F) are expected for at least 10 hours. Do not paint in the direct sun. Clean surfaces before painting them to get rid of dirt and flakes of old paint. If painting raw sanded wood, begin with a primer coat. Consult a paint supplier on the correct materials.

Cedar has a natural preservative in it but, nevertheless, staining will prolong its life. If left unfinished, cedar siding, shingles and shakes will weather to a grey colour.

When landscaping, keep the soil at least 200 mm (8 in.) below the lower edge of the siding to prevent water from damaging the siding, insulation and framing of the wall above the foundation.

**Troubleshooting
Cont'd.**

Mildew on cedar siding, shingles and shakes: Think about landscaping or other changes that would remove conditions (e.g., shade, dampness) that support the growth of mold. To remove mold, apply a solution of one part chlorine bleach to three parts water, with a soft brush. Wear rubber gloves, a dust mask and safety goggles, and cover nearby plants with plastic. Do not rinse away the solution. Repeat the treatment annually as a preventative, if mildew problems are anticipated.

**Builder's or
Homeowner's Notes**

Additional information on siding: brand, colour, warranty, etc.

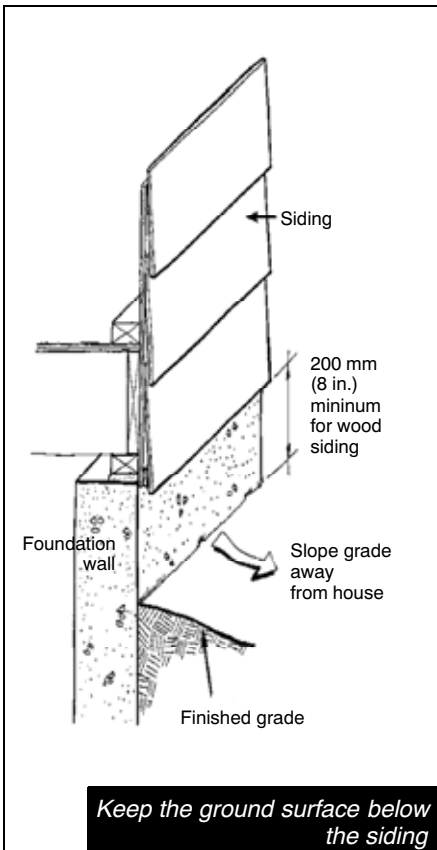

EXTERIOR FINISH: FIBREBOARD, VINYL OR METAL SIDING

Troubleshooting

Visible cracks in caulking: As the *Caulking* (page 71) ages, you must replace it.

Gaps in the siding, or buckling of metal or vinyl siding: Correctly installed, siding should be able to accommodate the expansion and contraction associated with changing temperatures (even in extreme conditions) without deforming, gaping or buckling. If deformities occur, it may be settlement of the structure that is causing the trouble. *Caulking* (page 71) may seal the gaps without having to replace the siding. Consult your builder or a contractor.

Cracks, discolouration, swelling or other signs of premature deterioration in fiberboard siding:

Leaks in the siding or water splashing against it can cause premature deterioration. Check the *Caulking* (page 71) and, if necessary, replace it. Also, check the siding for cracks caulking them as you go and look for other signs of deterioration. Make sure that no water is pooling against the foundation (*Grading and Drainage*, page 41; *Eavestroughs*, page 69). Often, you can reduce splashing by choosing an appropriate ground surface material (e.g., grass or rounded stones), or by installing eavestroughs or deflectors that direct roof water away from the side of the house.

If the cause of the problem is still unclear, or if the repairs within your scope have not corrected the situation, then contact your builder or a building contractor. Never let water-related problems go, as moisture can cause a lot of damage.

Description

The siding on your outside walls is either fibreboard, vinyl, or metal (aluminium or steel).

Care and Maintenance

To clean siding, lightly scrub any obviously dirty areas first, using a long-handled brush and a mild, non-abrasive detergent. Then hose the siding gently. Do not use a high-pressure stream, as this may force water through the siding.

Your fibreboard, vinyl, or metal siding should not need re-finishing, though you can repaint fibreboard and metal if you want. You cannot paint vinyl siding.

If you have the matching paint on hand, you can easily do minor touch-ups to fibreboard or metal siding, or the builder may do this for you at the end of the first warranty period. Be warned, however: colours fade with time, and a perfect match between old and new paint or siding is rarely possible, even if the colours come from the same batch. If you buy new paint or siding, it is bound to be slightly different in colour than the original lot. Builders will generally not repaint the whole house or large areas in order to match colours perfectly.

- ☛ Choose a dry day for painting, when temperatures of over 10°C (50°F) are expected for at least 10 hours. Do not paint in the direct sun. Clean surfaces before painting them to get rid of dirt and flakes of old paint. If painting a surface that has not been painted before (e.g., metal siding), begin with a primer coat. Consult a paint supplier on the correct materials.

When landscaping, keep the soil at least 200 mm (8 in.) below the lower edge of the siding to prevent water from damaging the siding, insulation and framing of the wall above the foundation.

**Troubleshooting
Cont'd.**

Damaged siding: Remove and replace a damaged piece of siding. Consult a home repair manual for guidance, or call your builder or a contractor for assistance.

**Builder's or
Homeowner's Notes**

Additional information on siding: brand, colour, warranty, etc.

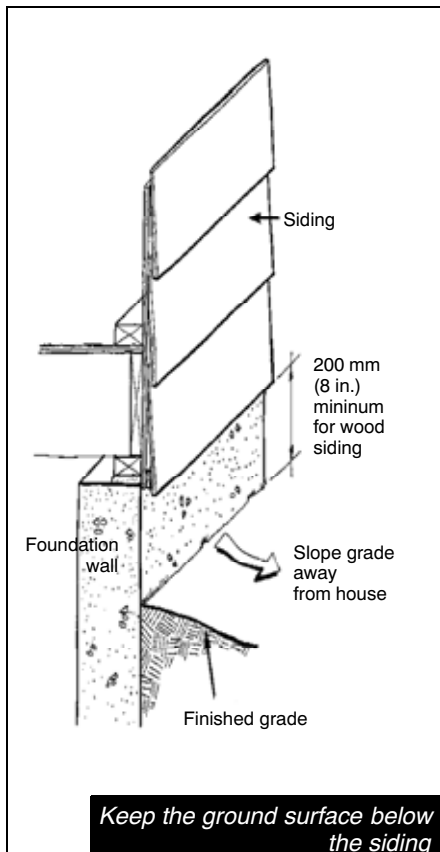

EXTERIOR FINISH: MASONRY

Troubleshooting

Deteriorating mortar: Don't worry about hairline cracks, but larger cracks or loose mortar may mean that it is time to repoint. This process involves cleaning out loose mortar to a depth of at least 12 mm (1/2 in.), and filling the space with new cement mortar. If the problem occurs within the warranty period, contact your builder. After that, consult a home repair manual for do-it-yourself information, or call on a professional contractor.

White "dust" on masonry: Efflorescence — the formation of white deposits on masonry — occurs when soluble salts dissolve in the wet mortar, then migrate to the surface as the mortar dries. This is common on new masonry surfaces. The deposit is not harmful and usually disappears in a while through normal weathering; or you can remove it, if you like, with water or light scrubbing. If efflorescence persists in a particular spot, however, it could indicate a problem: for example, water leaking through cracked mortar joints; moisture migrating from the inside of the house; or a damaged gutter or poorly positioned downspout (*Eavestroughs*, page 69). Investigate the source of the problem and correct it.

Flaking and crumbling bricks: If widespread crumbling is occurring, the bricks may belong to an inferior batch. Consult your builder. If the problem is localized, however, water may be entering the bricks, then freezing and expanding. Replace the damaged bricks, but before doing so, seek out the source of the water and stop it. Possible sources of water are: roof run-off; a leaking *Eavestrough* (page 69); or water that is splashing up against the house. Make sure that

Description

A masonry finish (or veneer) is made up of masonry units — such as bricks and stones (natural or synthetic) — with cement mortar holding them together. Metal connectors embedded in the mortar and fastened to the sheathing or wall studs "tie" the finish to the structure of the house (*The Whole House, An Overview*, page 13). Brick and stone finishes should last the lifetime of the house.

Clay brick is made of clay fired at a high temperature. The surface texture and colour are created or applied during manufacture. This surface protects the brick and should not be damaged.

Composite or cultured stone and concrete brick are cement products. The decorative surface serves no protective function.

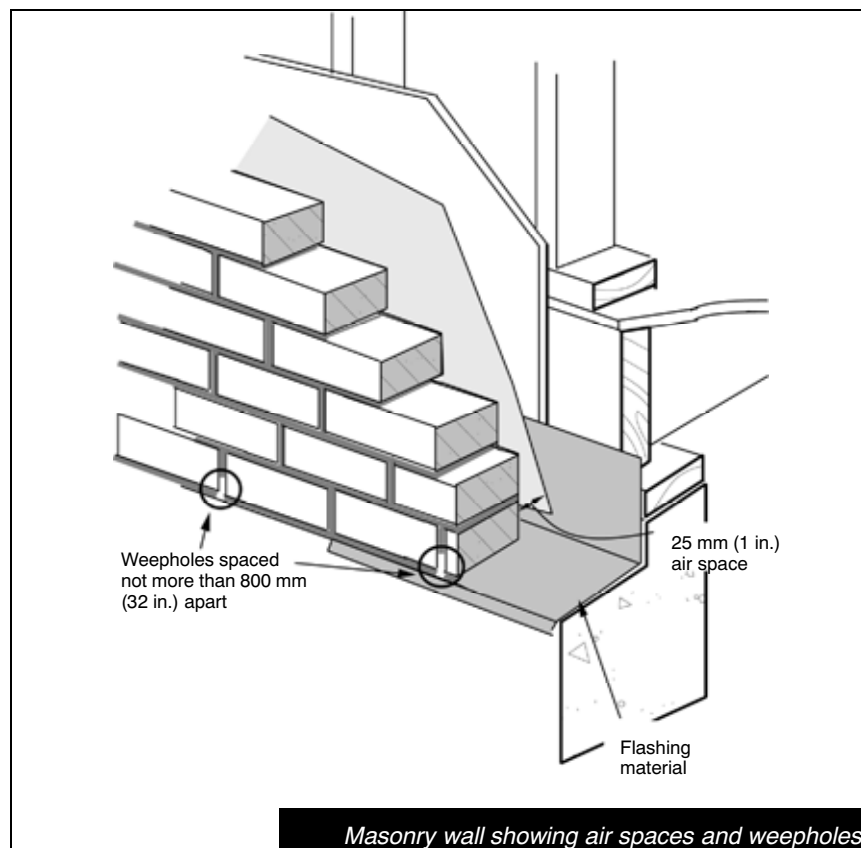

Masonry wall showing air spaces and weepholes

**Troubleshooting
Cont'd.**

water is not pooling against the foundation (*Grading and Drainage*, page 41). Often, you can reduce splashing by choosing an appropriate ground surface material (e.g., grass or rounded stones) or by installing eavestroughs or deflectors that direct roof water away from the side of the house.

Care and Maintenance

Generally, masonry needs little maintenance, although heavy or continuous exposure to water and ice will damage it (*Roofing*, page 58 and *Eavestroughs*, page 69). Mortar usually lasts around 25 years — less in some exposed areas — before the outer layer has to be chiselled out and replaced; a process called “re-pointing.”

If you have to clean the brick, avoid damaging the surface. You can contract a professional brick cleaner, or try any one of the following techniques (starting with the first and least damaging):

- Flush the surface with a spray of water from the garden hose.
- Gently scrub the surface with water and a soft brush.
- Use a brick-cleaning solution, available at hardware stores. Follow the manufacturer’s instructions.
- ⊕ Commercial brick-cleaning solutions can be toxic, corrosive and flammable. Wear rubber gloves and safety goggles and take other appropriate precautions.
- ⊖ Do not paint brick. Moisture trapped by the paint can damage the brick; and the wall will look shabby as the paint deteriorates. Removing the paint may damage the brick.

Water that gets into the air space behind the masonry is allowed to drain through small holes (weepholes) set in the base of the wall and above windows and doors. Never fill up or cover these holes. Similarly, do not block the vent holes at the top of the masonry wall.

When landscaping, keep the soil at least 200 mm (8 in.) below the lower edge of the masonry to prevent water from damaging the finish, insulation and framing of the wall above the foundation.

**Builder’s or
Homeowner’s Notes**

EXTERIOR FINISH: STUCCO

Troubleshooting

Cracks and loose areas of stucco:

Chances are by the time you notice an area of disintegrating or detaching stucco, a larger area will be already affected. To sense the extent of the problem, tap the wall around the damaged area with a hard object and listen for a hollow sound. Break away all loose stucco and—before replacing it—find and address the source of the problem.

If settlement or structural shifting has caused the stucco to crack and loosen, consult your builder or a contractor.

Water getting into the wall may be the culprit. Water damages wood structures and, as it freezes in winter, weakens the bond between stucco and the wall. Make sure the stucco is not exposed to roof run-off. Also make sure that water is not pooling against the foundation or splashing up onto the stucco (*Eavestroughs*, page 69; *Grading and Drainage*, page 41). Often, you can reduce splashing by choosing an appropriate ground surface material (e.g., grass or rounded stones) or by installing eavestroughs or deflectors that direct roof water away from the side of the house.

Description

Stucco is a siding material made from Portland cement, sand, lime and water. Stucco is divided into panels with the joints between them allowing enough play in the surface to prevent the stucco from cracking during normal settlement or shrinkage in the building frame. The stucco on your home was applied either:

- in three coats over a mesh of metal (called a lath) nailed to the frame of the house; or
- on a fibreglass reinforcing textile laid over rigid insulation and secured to the frame of the house.

Care and Maintenance

Stucco is a durable material that should last at least 25 years. Natural shrinkage often causes hairline cracks to appear in newly completed stucco — particularly in trowel-finished stucco. Leave these initial cracks alone for two years, until shrinkage has finished; then fill and cover the cracks, and apply a brush coat of compatibly pigmented cement. Repainting can also improve the appearance of stucco.

Maintain the *Caulking* (page 71) in good condition around all pipes and intake and exhaust hoods.

When landscaping, keep the soil at least 200 mm (8 in.) below the lower edge of the stucco to prevent water from damaging the siding, insulation and framing of the wall above the foundation.

Builder's or Homeowner's Notes

EAVESTROUGHS

Troubleshooting

Overflowing eavestroughs: Overflow has several possible causes:

- Ice may have blocked the gutter or downspout. Roof snow that melts when exposed to the sun has a tendency to freeze at the eaves, forming icicles that can block gutters or downspouts. Pouring hot water into the blocked gutter or downspout usually fixes the problem.
- If debris has blocked the downspout, you may be able to clear it with a strong jet of water. Insert a hose in the bottom of the downspout, stuffing rags all around so that the full force of the water is directed up the pipe. If the obstruction does not clear, you may have to work a plumber's snake through the top section or take the downspout apart at the elbows to clean it by hand.
- If the eavestroughs are not blocked, but they commonly overflow in heavy rains, the trough may not slope enough. Consult your builder or a contractor.

Dripping along the fascia: If water drips between the fascia (the front edge of the eaves) and the eavestrough, you may need to have drip edge flashing installed under the shingles along the eaves.

Description

Eavestroughs consist of gutters (plastic or metal troughs that collect water run-off at the edge of the roof) and downspouts (vertical drains that carry water from the gutters to the ground). Eavestroughs divert rain and snowmelt away from the foundations or from other areas where water could cause problems.

Downspouts sometimes drain onto splash pads — usually concrete paving stones — which direct rainwater away from the foundation. Splash pads also control soil erosion at the mouth of the downspouts: erosion leads to pooling around the *Foundation Wall* (page 50), and ultimately to foundation damage and overloading of the foundation drainage system. Sometimes, downspouts connect to the storm drainage system or extend at the bottom to deliver rainwater to a distance of about 1 m (40 in.) from the foundation wall.

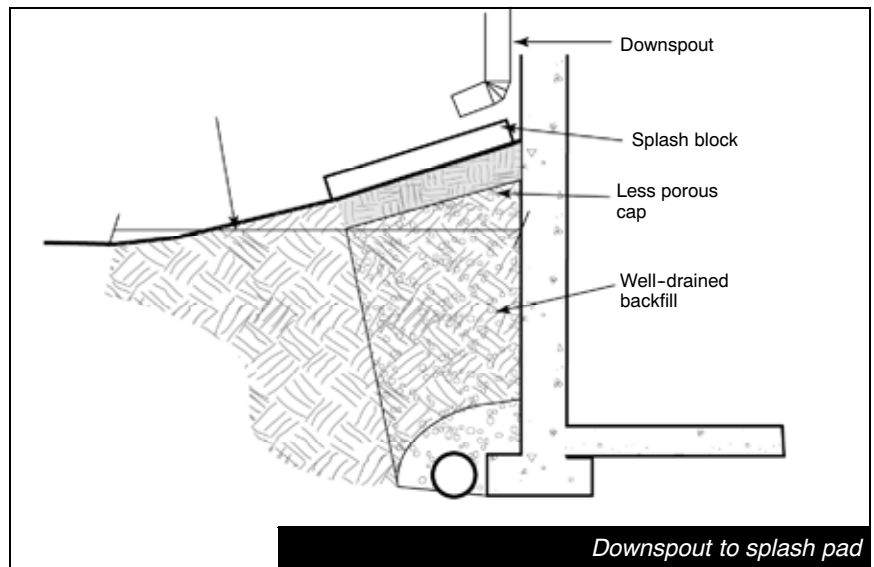

Care and Maintenance

At least once a year, clear away leaves and other debris from your gutters. If there are trees near the house, this clear-out is best done in the autumn, after the leaves fall. Wear heavy gloves when clearing your gutters and use a trowel to lift the matted leaves. Start at the end of the gutter nearest the downspout.

Eavestroughs

Additional Tips



To collect rainwater for lawn and garden watering, put a rain barrel underneath the downspout. Make sure that an overflow pipe directs excess water from the barrel away from the house. Do not use roof run-off from an asphalt roof to water vegetables or other edible plants.



If you use a ladder when cleaning gutters, make sure it is in good repair and position it solidly before you begin to climb.

In winter, gutters and downspouts often cease to work as they fill with ice. That winter build-up can damage eavestroughs. Check them every spring for leaks or for sections that are low (where water will pool), or only loosely attached to the roof. Use a hose to flush out the eavestroughs, starting at the upper end (away from the downspout), clearing away winter debris and at the same time checking for leaks and pooling. Hosing will also show if all the downspouts and their extensions are working right: this is important because, if the extensions detach or leak, water will soak into the ground right at the foundation. Make sure that the splash pads are intact and in the right position.



It is not hard to clean, repair and replace eavestroughs, but working on a ladder can be dangerous. Think about calling an experienced contractor.

Builder's or Homeowner's Notes

CAULKING

Troubleshooting

Water leaks in at windows or doors: The exterior caulking may have failed. However, the problem may also be caused by damage to the roof or to the flashing immediately over the window or door (*Roofing*, page 58).

Additional Tips

If you intend to paint the caulking, be sure to buy a paintable type. Before applying new caulking, you may have to remove damaged caulking. When caulking is used to fill a large gap (6 mm or 1/4 in. or more), you may find back-up material wedged into the cavity to help make the seal and hold the caulking in place. Do not remove or dislodge this material.

Before you begin to caulk, read and follow the specific directions on the tube. Here are some general instructions:

- Place the tube in the caulking gun and pull the trigger to bring the plunger forward against the tube.
- Cut the nozzle of the tube at a slight angle (around 20°) and at a point where the flow of caulking will be large enough to cover both sides of the crack. Use a nail to pierce the inner seal inside the tube.
- To force the caulk into the crack and fill it completely, push the caulking gun along at right angles to the crack or joint.

Description

There are various kinds of flexible sealing compounds, called “caulking,” with each variety intended for a different purpose and material. Weatherproof exterior caulking seals all openings in the exterior of the house (e.g., wherever pipes, hose connections and vents penetrate the walls) and makes the outside of your house weather tight. Caulking also seals seams (e.g., at corners where siding comes together, and around doors and windows). Most caulking comes in a tube and is applied with a caulking gun.

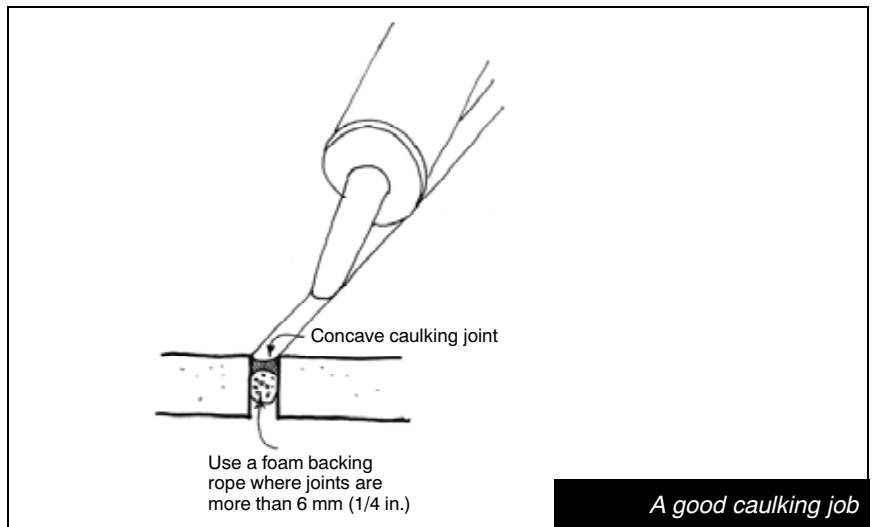

Another kind of caulking is “acoustic” caulking. It is used to seal gaps in the air and vapour barriers in outside walls and ceilings (e.g., around electrical outlets, lights, fans and fixtures). (See *The Whole House, An Overview*, page 13, for an explanation of these terms.) Acoustic caulking cannot be seen, as it is hidden inside the walls.

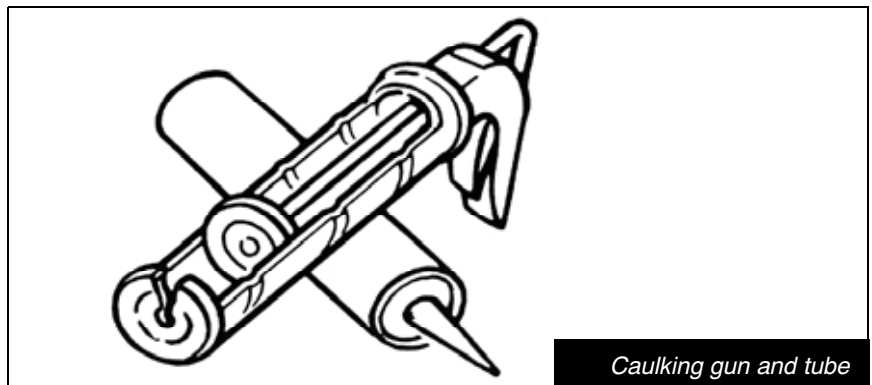

Additional Tips Cont'd.

- Squeeze the trigger gently and control the speed at which you move the nozzle so that the caulk runs slightly ahead of the gun and rises slightly behind it. The caulk should adhere to both sides of the crack, with enough overlap to allow for some shrinkage or movement.
- When finishing a line, push the nozzle into the caulking and twist as you remove it.
- Most types of caulking can be gently smoothed out, while still fresh, with a wetted sponge.
- Allow the caulking to set properly before painting or exposing it to water.

 Different types of caulking vary in the amount of gas released. Select a low-odour caulk appropriate for the intended application. Ventilate the work area well. When working indoors, keep children out of the area for several hours.

Other kinds of caulking are used to fill cracks between drywall and woodwork and to seal joints around taps, bathtubs and plumbing fixtures (*General Information*, page 87).

Care and Maintenance

Your house has been sealed with good quality caulking, which should last many years. However, some cracks will probably occur as the new house goes through the normal “settling in” process (*The First Year*, page 30). Check the caulking once a year and replace any that is damaged.

Caulking is readily available at any hardware store, and is easy for a handy homeowner to apply. Especially for exterior caulking work, buy high quality caulking compound. Before beginning work, make sure that all surfaces to be touched by caulking are clean and dry. Caulk only when the weather is dry and the temperature is above 7°C (45°F).

When sealing seams and openings in siding, be careful not to fill in the drainage holes along the bottom edge. When caulking masonry walls, treat the weepholes over windows and doors and at the bottom of the wall in the same careful way.

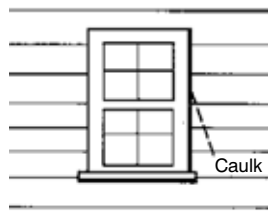

Between window and door frames and the exterior finish

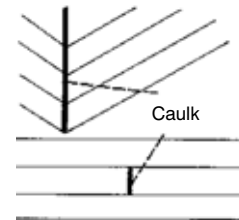

At corners and other joints in siding

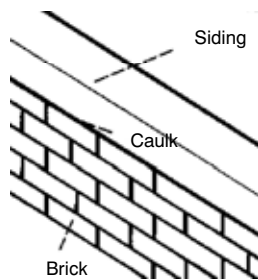

At joints between siding and masonry

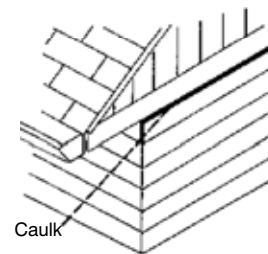

At the underside of eaves where wall and eave meet

Caulking locations

STAIRS, PORCHES AND DECKS

Troubleshooting

Cracks between concrete stairs or landings and the house foundation:

Cracks in this location indicate different rates of settlement. Small cracks (less than 3 mm or 1/8 in. wide) are common and nothing to worry about, as long as water is not gathering in them and running into the foundation. Seal these cracks periodically with an exterior grade of caulking, available from any hardware store, making sure that it is compatible with the particular kind of concrete. If settlement has finished, you can use concrete grout and epoxy to fill the crack more permanently. If cracks are large or growing, contact your builder or a contractor.

Loose or crumbling concrete: A chemical is usually added to concrete to prevent winter freeze and thaw from “spawling” the surface. Consult your builder if spawling occurs, or contract an expert to refinish the concrete, using a purpose-formulated concrete mix.

Gaps between wood structures and the house: Winter frost heaving or the settling of ground around the house can cause gaps. Slope the ground around and under the stairs, porches and decks so that surface water drains away from the house (*Grading and Drainage*, page 41). Similarly, if regrading, do not allow water to run toward the house foundation. Raise a wooden structure that has settled by inserting shims or blocks and securing them in place where the structure rests on the foundation posts. If settlement of a porch has caused a gap to open between the porch roof and the house, consult an expert who will check that the structure is properly attached, and the roof junctions are intact.

Description

Most houses have stairs and landings (the platform at the top of the stairs) at the entrances. Some houses also have one or more decks or covered porches.

- Concrete stairs and a landing may have been built at the entrance (or entrances) to your house. These are either freestanding on the ground, without foundations, or they are supported on a foundation wall linked to the house foundation.
- The uninsulated area under the stairs and landing may be set up as a cold storage room and fitted with floor and door. Such rooms usually vent directly to the outside.
- Your house may have the following wooden structures made of cedar, pressure-treated lumber (with a typically greenish hue) or painted wood.
 - wood stairs and a landing at the entrance (or entrances) to your house;
 - a wooden deck;
 - wooden railings, columns or porch roof.
- The floor surfaces (decking) of your landings, porch and deck may be made of a durable recycled plastic product that needs no refinishing.

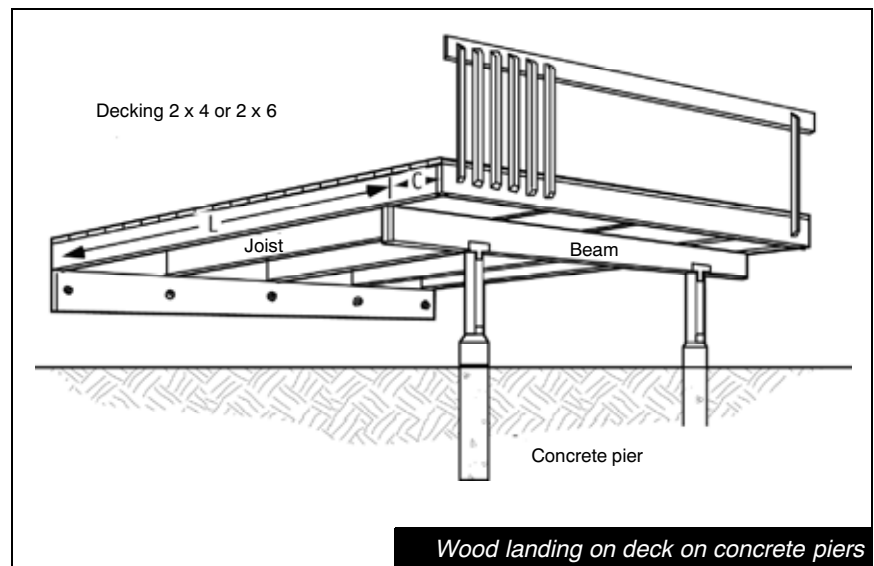

**Troubleshooting
Cont'd.**

Damaged or deteriorated wood:
Water, either from splashes or a roof leak, may have caused the damage. Check for water leaks when it is raining or the snow is melting, and stop them. Then, let the wood dry out completely before repainting or refinishing it.

Care and Maintenance

Maintain the grade (*Grading and Drainage*, page 41) to direct run-off away from the area under decks and porches. Wet ground expands and contracts with winter freeze and thaw, and this would cause decks and porches without full foundations to shift.

The concrete used in stairs, landings and porches generally needs little maintenance. Concrete may be sealed with a purpose-made sealer, available at any hardware store. However, painting concrete is not recommended, as most paints wear off quickly. Paint can also seal in moisture and will bubble after prolonged exposure to weather.

Pressure-treated wood is not meant to be finished and, at the very least, should not be painted in the first couple of years. Cedar does not need to be painted; if left unfinished for several years, it will weather to a soft grey. Painted, stained or sealed wood that is exposed to high wear (e.g., decking) will need to be refinished every one to three years to maintain its appearance. To protect wood in less high-wear locations, refinish it every five to ten years, depending on the level of exposure. Keep wood surfaces free of snow to prolong their life and finish. Before applying new paint or *Caulking* (page 71), scrape off any loose, bubbled paint and old caulking.

For additional information on maintaining exterior wood, see *Exterior Finish: Wood Siding and Wood Trim*, page 62.

**Builder's or
Homeowner's Notes**

GARAGE OR CARPORT

Troubleshooting

Cracks in the concrete floor: The small cracks caused by shrinkage may be impossible to prevent. Patch the cracks with caulking specified for this purpose, then apply a sealing compound to prevent water and chemicals from flowing into them. Check that the floor drains toward the garage door or to a central drain. Report any significant cracking, particularly if coupled with drainage disruption, to your builder.

Garage door motor runs but door does not move: Check that the drive chain is engaged with the door.

Garage door does not stop in closed position, reopens after closing: Check that there are no obstructions under the door (e.g., winter ice accumulation) and that the bottom edge of the door is normal. If the problem persists, follow these steps in sequence:

- Pull the hand-release cord to disengage the drive chain from the door and close the door manually.
- Activate the door mechanism. Although disengaged, the motor will run the full length of the chain, as if it were actually closing the door.
- Re-engage the chain.

Too long or too short a delay between the opening and closing of the garage door: The timer can usually be adjusted. Check the manufacturer's instructions, but if the method is unclear, contact the builder or a local door supplier.

Garage fumes in the house: Check that the door between the garage and house is closing properly and that the weatherstripping is in good condition. It is important that the walls and ceilings between the garage and house are fully airtight: if you suspect leakage, contact your builder or a contractor.

Description

A garage is a fully enclosed parking and storage space that usually attaches to, but is insulated from, the house. A carport is an open, roofed structure, either freestanding or attached to the house, and built out over a section of driveway.

Most garages and carports have wood-frame construction, while the *Exterior Finish* is often the same as that used on the house. Where the garage attaches to the house is a layer of drywall board which provides some protection to the house in the event of a fire in the garage.

A concrete slab on the ground forms the floor of the garage. The type of concrete used, and the floor's surface texture, help it to resist damage from water and freezing. The floor may have saw cuts or control joints,

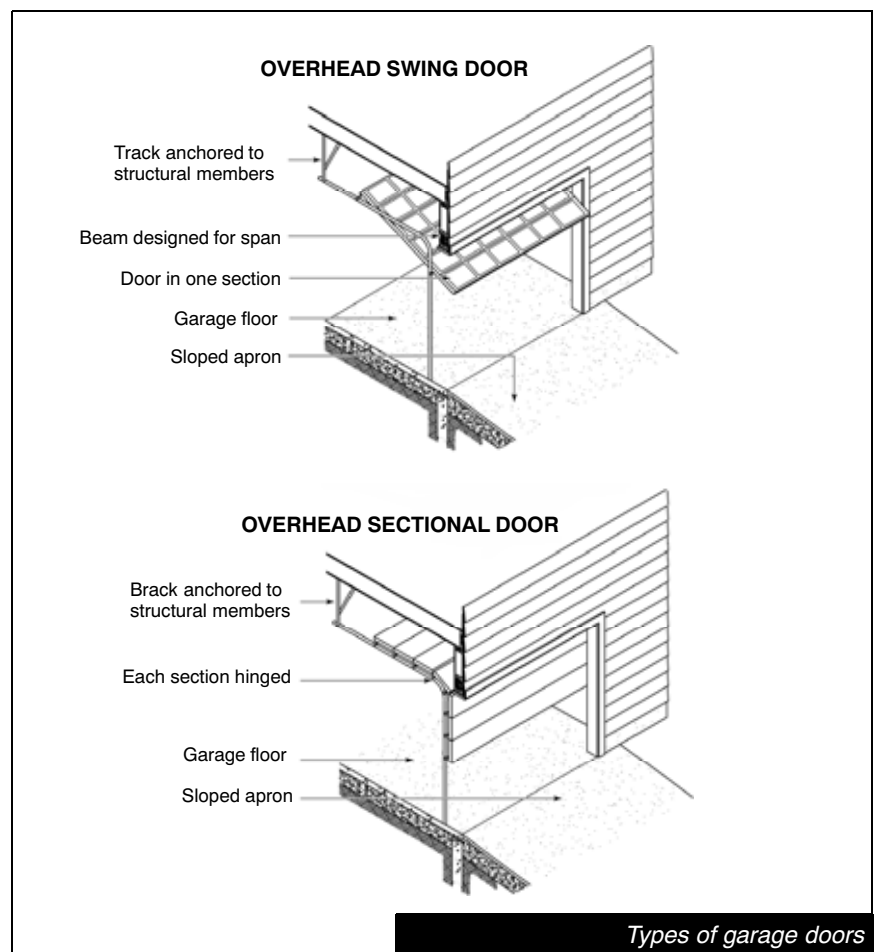



Additional Tips

 Do not run the car inside the garage. Even with the garage door open, there is a risk of toxic fumes if the wind is blowing the wrong way. Let the car warm up outside the garage, therefore, and keep the garage door open for a moment after bringing the car in.

 To minimize the risk of fire, do not store flammable materials in the garage.

Keep your garage closed during below-freezing weather. Although the garage foundations are frost-protected, an open door increases the risk of heaving foundations during long periods of extreme cold.

  Because a garage tends to buffer the house, insulating the garage walls can reduce the cost of heating your house in winter.

If you need open access to the garage for a period of time, open the door, then use the hand-release to disengage the drive chain from the motorized opener.

 While away from the house for a period of time, as a security measure, disengage the cord of the closed garage door.

which you can caulk to prevent water entry. These help minimize the risk of cracking as the concrete goes through normal shrinkage.

The garage door is made of wood, plywood, fibreboard or sheet metal. It runs on a pair of steel guide tracks with rollers.

- Your garage door may have a motorized opener suspended on a frame from the ceiling of the garage. The drive chain is the mechanism that links the motor to the door and causes the door to open and close. It is possible, by pulling the hand-release, to disengage the drive chain. If anything interferes with the door as it is closing, it will automatically reopen.

You can activate the motor that opens and closes the garage door both from a switch on the inside wall of the garage and from a battery-operated remote control device (usually kept in the car so that the door can be opened from outside the garage). Your remote control device has been coded to open only your door, thus preventing someone with a similar device from entering. A timer delay allows enough time for the car to enter or leave before the door closes again. A time delay light may also come on for several minutes when the door opens.

The door between the garage and the house is fire-protected, and it has an automatic device to ensure that the door closes fully behind you. These features, along with good weatherstripping (*General Information*, page 79), help to prevent the spread of odours, dangerous gases and fire from the garage to the house.

Operation and Maintenance

-  Keep the door between the garage and the house closed to stop car exhaust from filtering into the living quarters and to maintain a fire barrier. Check the weatherstripping annually (*General Information*, page 79) and make sure that the door continues to seal well. Also, look to see if the automatic closer is operating properly.

You may want to seal the concrete floor for enhanced protection and durability; however, allow the concrete to cure for at least one month, and preferably longer, before you do so. You can find high-quality, water- and chemical-resistant sealants at any hardware or paint store. Where you have caulked the saw-cuts in the floor slab, repair or replace the *Caulking* (page 71) at least every 10 years, or when it is damaged; but make sure you use the right kind of caulking.

Check the manufacturer's manual for instructions on how to maintain the garage door. Generally speaking, the motor, chains, rollers and other

Part Two — Roof, Outside Walls, and Other Exterior Features

moving parts of the garage door and door opener should be lubricated at least once a year.

For information on repainting your garage or carport, see *Exterior Finish*. Repaint any exposed wood. Also, remove rust on exposed steel parts and paint areas that are prone to rust.

**Builder's or
Homeowner's Notes**

Garage or Carport



PART TWO

DOORS AND WINDOWS



GENERAL INFORMATION

Troubleshooting

Drafts or noticeable outdoor sound penetration through closed doors or windows: Drafts or noticeable noise (e.g., traffic which makes a distinctive whisper-like sound) may mean there are gaps around doors and windows. Check the weatherstripping and *Caulking* (page 71) for signs of wear and replace them, if necessary. An uneven gap between the frame and the door or the window sash suggests that the building has settled. A certain amount of settlement is normal; however, gaps that are larger than 5 mm (3/16 in.) point to excessive settlement — either that, or the door or window was not properly installed. In either case, contact your builder.

During the first year, the drying out process may cause minor problems with the fit of doors, and these may correct themselves (*The First Year*, page 30). If the problem remains toward the end of the first year, contact your builder.

Overview

Exterior doors and windows serve a range of purposes: they permit safe access; they allow in the light and fresh air; and they keep water and drafts out and the heat in. The frames of exterior doors and windows are built into the wall, where they join to air and vapour barriers (*The Whole House, An Overview*, page 13), and connect to the inside and outside finishes.

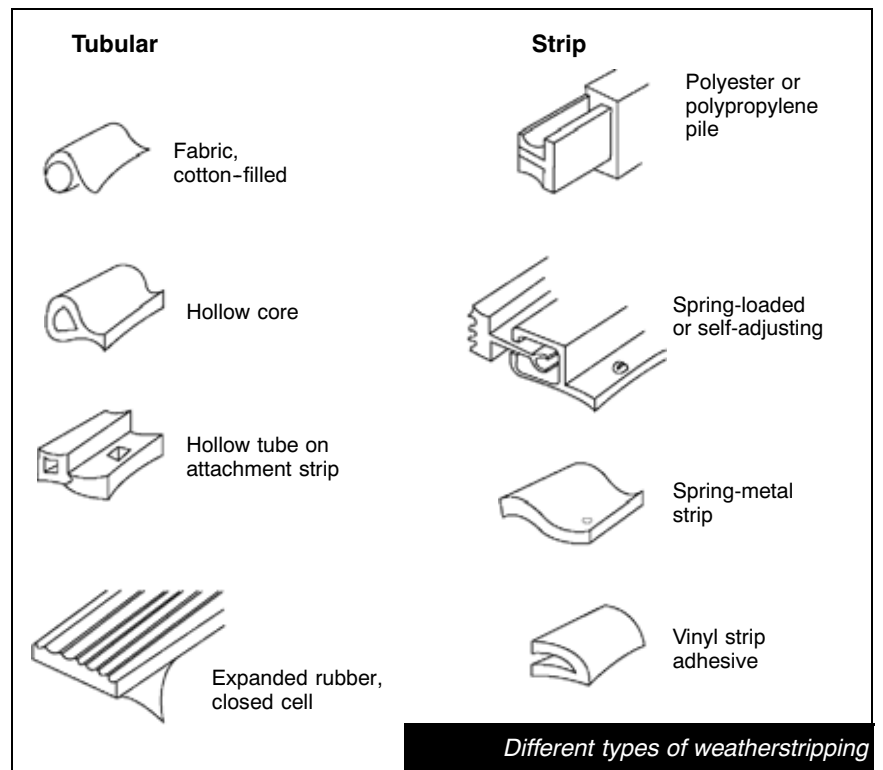

Weatherstripping is a manufactured product that comes in a variety of materials (e.g. vinyl, rubber, neoprene) and in long strips that can be cut to measure. Its purpose is to help make an airtight seal between the frame and the window and door openings. Of course, weatherstripping cannot compensate for warped windows or doors, but it does tend to preserve a good seal in the face of minor shifting or shrinkage. Examples of different types of weatherstripping used in different locations include:

- pressure seals, used for hinged doors and windows;
- magnetic seals, used on steel doors;

General Information

- sliding contact seals, used for sliding windows and patio doors;
- sweep-style seals or threshold weatherstripping, used along door bottoms; and
- foam strip weatherstripping, used for the attic access hatch.

Maintenance Tips

Where doors and windows or their frames are made of wood, regular cleaning will prevent the development of wood-eating mold. Repaint the wood when the existing paint blisters or cracks (normally required every three to five years).

Once a year, apply petroleum jelly to rubber, vinyl or neoprene weatherstripping to keep it flexible. Replace weatherstripping when it becomes brittle and cracks easily, or has lost its flexibility.

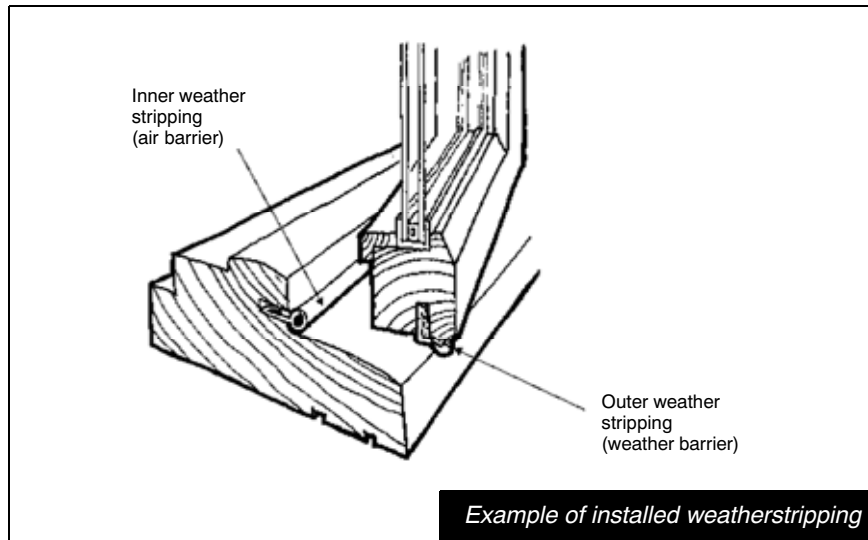

Builder's or Homeowner's Notes

DOORS

Troubleshooting

Door hinge is squeaky: Squeeze a drop of household oil on to the top of each hinge, and swing the door several times to work the oil into the hinge. If the squeaking continues, lift the pin from the hinges and apply more oil. When finished, wipe any spills or excess oil off the outside of the hinge.

Handle or lock is squeaky: Lubricate the handle where it turns against the door's fixed plate. Lubricate the lock at the latch. Powdered graphite is the best lubricant, but it can be messy, and a light machine oil will also work. Wipe off excess lubricant.

Drafty exterior door: Possible causes and solutions are described in *General Information* (page 79). Sometimes, you can correct a gap between a door and its frame by inserting a thin sliver of wood (a shim) behind one of the hinge plates.

Door rubs or sticks: There are many possible causes:

- **Loose hinges:** Tighten the hinge screws on the door and frame.
- **Swollen or warped door:** A wooden door will swell slightly in conditions of high humidity. Try lightly sanding the edges of the door and the frame where they rub together. Look for a shiny spot on the door: that is where it is sticking. If you plane the bottom edge of the door to make it fit, you should paint the raw edge or otherwise seal it.
- **Frame shifted out of square:** Structural settlement can shift a door frame, causing the door to rub or stick at some points, and creating gaps at others. Sand or plane the wooden or fibreboard edges where they are rubbing. (Refer to *Additional Tips* for guidance on removing the door from the frame.) Alternatively, try shimming one of the hinges. If gaps are greater than 5 mm (3/16 in.), do not try planing or shimming. Instead, contact your builder or a doors and windows expert.

Description

Your entry (exterior) doors may be made of:

- a foam core covered by a veneer of wood or steel;
- solid wood.

Leading out to your back yard or deck, you may have:

- sliding (patio) doors;
- hinged terrace (French) doors.

Patio and terrace doors normally come with a screen door.

Inside doors are usually “hollow core,” with a plywood or fibreboard veneer. If you have an attached garage, between it and the house there is a fire-rated door equipped with an automatic closer: this door is made of steel over a foam core or wood veneer over a solid wood core.

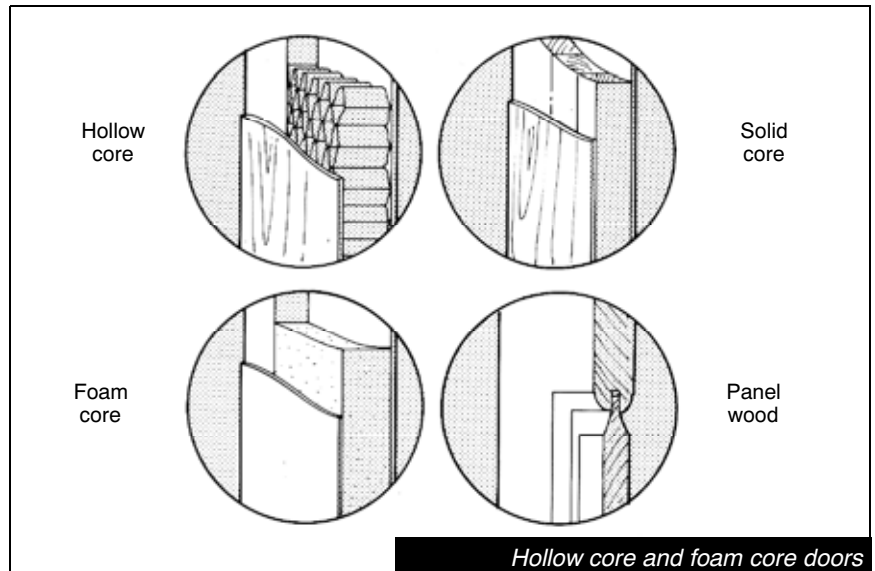

Door “hardware” refers to hinges (which attach to the frame), door handles and locks. There are also various kinds of rubber-tipped “bumpers” that screw on to the baseboard behind the door or on the wall at handle-level. These prevent the door handle from damaging the wall when someone opens the door abruptly.



For garage doors, see *Garage and Carport* (page 75). Cabinet doors are covered in *Countertops and Cabinets* (page 99).

Troubleshooting Cont'd.

Door drags across carpet: Try tightening the screws that attach the hinges to the door and frame. If the hinges are well secured, remove the door (see *Additional Tips*) and sand or plane its bottom edge.

ⓘ Minor problems with the fit of the door during the first year may correct themselves. If the problem remains toward the end of the first year, contact your builder.

Outside steel door is bowing: In very cold weather, the outside face of the door may shrink, causing a slight bowing. Don't worry. As long as the door is weather-tight and opens and closes properly, it is doing its job. If the latch or lock will not engage, you may have to adjust the hinge or lock plate. Consult a home repair guide.

Bathroom or bedroom door is accidentally locked: Some bathroom and main bedroom doors have privacy locks, and these are usually activated by pushing and twisting either the whole handle or a little knob in the centre. To unlock the door from the outside, push a thin wire or nail into the small hole in the handle. If the lock has a slot rather than a hole in the handle, it may have come equipped with a pin to unlock it. A coin or small screwdriver will also work.

ⓘ Learn how to unlock the door from the outside before an emergency arises.

Key won't turn in lock: In cold weather, moisture may freeze in a lock, effectively jamming it. Try a commercial lock de-icer (available in hardware stores). Alternatively, use a flame or hot water to heat the key, then insert it in the lock and turn it gently as far as possible; repeat until a full turn is possible. (If you are using hot water, make sure the key is dry before you insert it in the lock.) If the lock is not frozen, the cylinder in the lock may have shifted, or the locking mechanism may be damaged. Consult a home repair guide or call a locksmith.

Operation and Maintenance

In preparing for winter, remove the screen doors from the patio doors. First, open the screen a bit, then lift the screen up into the top track, free the door from the bottom track and pull it out. If you have trouble getting the screen clear of the bottom track, try squeezing the sides of the screen door in as you lift.

ⓘ Some screen doors have screws or a guide that you must remove before pulling the door out of the track.

The original finish on outside door handles and locks will wear with normal use. For a natural weathered look, remove the remaining finish with a mild scouring powder; to restore the handles to a look-like-new shine, polish and lacquer them. Polish other indoor hardware with a soft cloth.

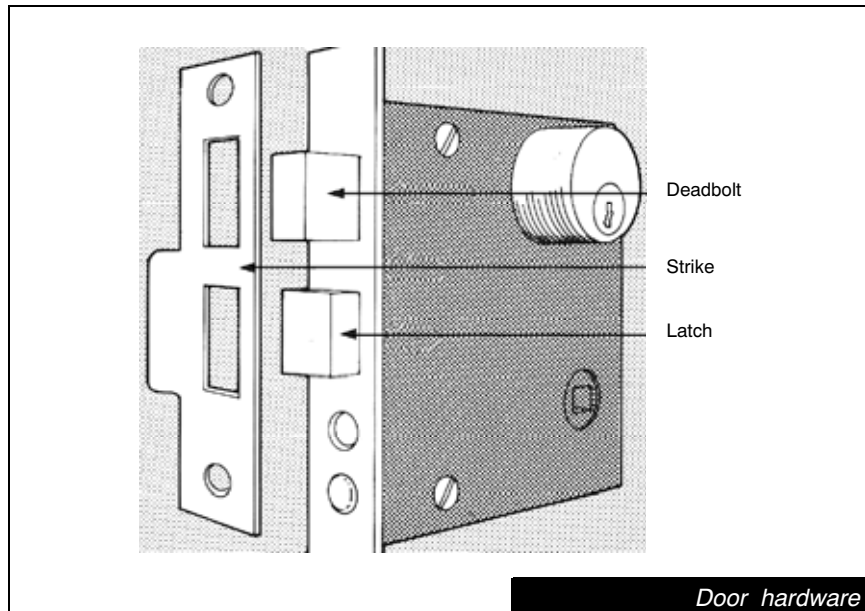

Door hardware

Every few years, refinish exterior wood doors to prevent warping. Simply scrape off the loose paint and repaint (*Exterior Finish: Wood Siding and Wood Trim*, page 57). Whenever sanding or planing exposes raw wood, you should protect it by resealing or painting. Painting also reduces a door's tendency to absorb moisture and swell. Repaint scratches on steel doors to prevent rust.

Additional Tips

When removing a door, begin by taking out the pin in the bottom hinge. The pin can be dislodged using a thin screwdriver and hammer. Once the pins from both the bottom and top hinges are removed, lift the door off the hinges. When reinstalling the door, replace the top pin first.

If the hinge screw will not catch, it is likely that the wood has been stripped. Put some white carpenter's glue in the hole and insert wooden matchsticks (remove the head) or toothpicks. Wait for this to set before attempting to re-install the screw.

ⓘ Especially if you are alone in the house, identify callers before letting them in. Look through the window or peephole, if your door has one, or install a chain guard that will allow you to open the door partially (*A Safe and Secure Home*, page 26).

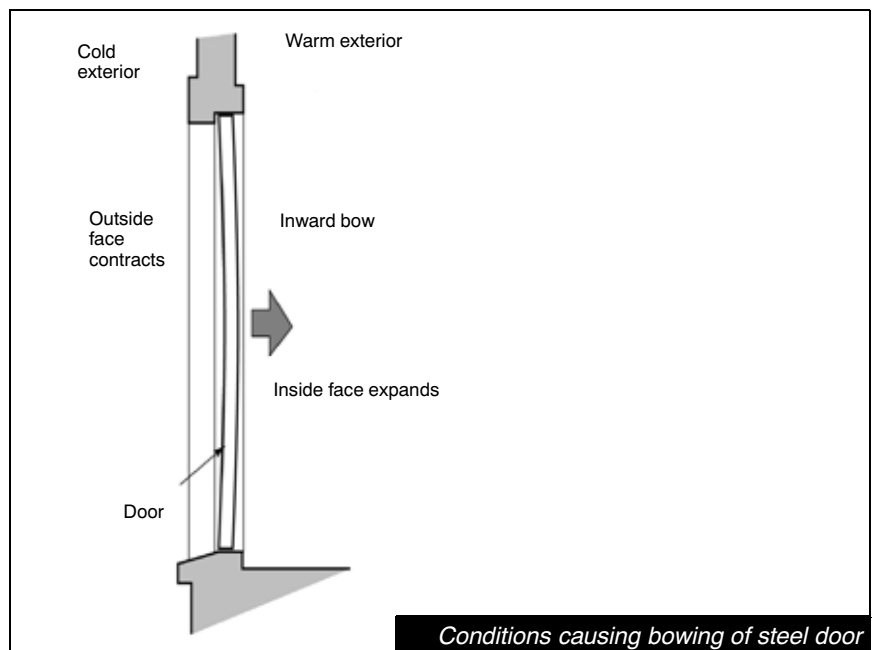
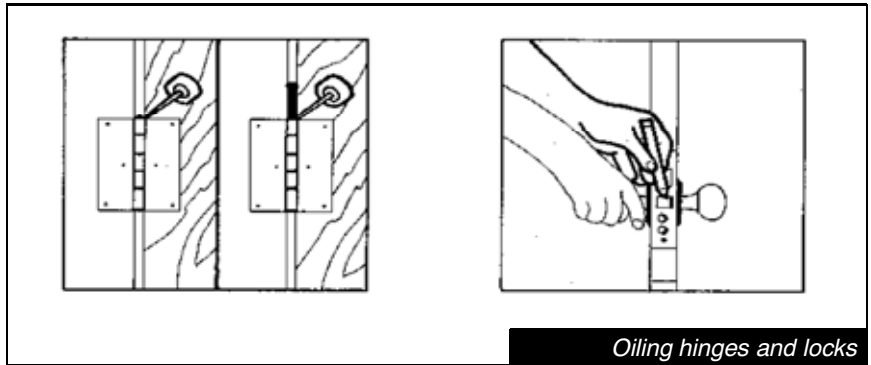

Builder's or Homeowner's Notes

WINDOWS

Troubleshooting

Drafty windows: On cold days, even an efficient, well sealed window may feel drafty (*General Information*, page 79). This drafty feeling is caused by convection: cold air from the surface of the glass literally falls off it. The builder has tried to offset the effects of cold air convection by locating heat sources in your house as near as possible to the windows. Curtains and blinds over the window can also help, as they slow the flow of air. However, if there is condensation on the windows, let the air circulate freely.

Condensation on windows, mildew and wood damage:

Condensation on window panes is usually a sign that steps should be taken to control humidity in the house (*The Environment in Your House*, page 17). Where there is a lot of condensation, water drips down the glass to the frame, where it creates the ideal conditions for mold growth. Immediately wipe up water that collects on window sills.

Condensation or dirt between the layers:

A crack in a double-glazed window or the failure of a seal around the edges allows moisture or dirt to enter. When that happens, an argon-filled window loses some of its ability to keep heat in; however, the loss may not be significant enough to justify window replacement.

Broken window: If you are unable to replace a cracked window immediately, stick duct tape over the crack to prevent it from spreading. If a window breaks entirely, put on heavy gloves to remove the loose pieces of glass, starting at the top. Then, staple or tape plastic over the opening. If it is windy or cold out, tack a sheet of heavy cardboard or plywood over the plastic. You will have to order a new sealed glazing unit from a manufacturer or building supplier.

Description

Though windows come in many shapes and sizes, they all have certain things in common. For example, all windows have frames with side jambs, a bottom sill and a top. The casing (or trim) covers the edge of the frame where it meets the wall. The sashes are that part of the window that holds the pane or panes of glass in place. To open a window you move the sashes, either by sliding them or turning them on hinges. Fixed windows are those that do not open.

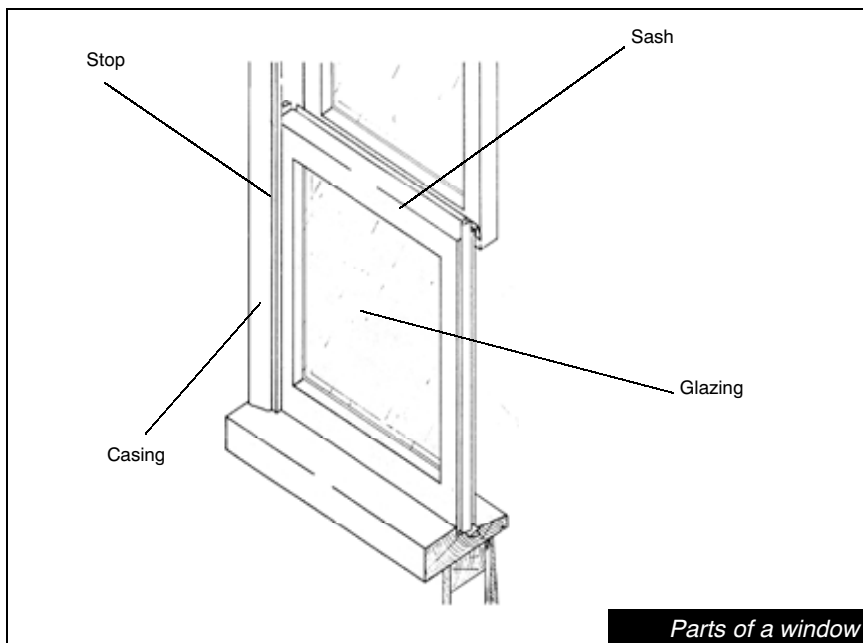

Parts of a window

Window hardware — the exact type depending on the particular window — includes an opening mechanism, with a range of positions between open and closed, and a locking mechanism to secure the window.

Most window panes are made of glass, except for specialty windows (e.g., skylights), which are sometimes made of acrylic. Safety glass is now standard in doors and skylights and is occasionally used in larger window units. Laminated safety glass (two or more layers of glass with a plastic film between them) cracks but does not shatter. Tempered safety glass fragments into relatively harmless rectangular pieces.

The energy efficiency of windows has improved dramatically in recent years. Double-glazed units (two layers of factory-sealed glass) are now standard in windows and exterior doors. Air or a dense gas, such as argon, is sealed between the layers to reduce the flow of heat. Various

Additional Tips



Window screens are not secure enough to bear much weight against them. Never allow a child to lean against the screen of an open window.



Use windows, window shades and vegetation to keep your house cool in summer (*Landscaping and Vegetation*, page 43; *General Information*, page 101).

You can open windows to bring fresh air into the house; but, for consistent and balanced ventilation and air circulation, you are better off using mechanical ventilation properly (*The Environment in Your House*, page 17).

special coatings are now applied to high-performance windows, primarily to help keep winter heat in. The sash material and the seal between the sash and the glass also affect the energy performance of a window. Wood, vinyl and fibreglass, for example, are all good insulators. A good window in the right place can actually result in a net gain of heat, because solar gain during the day more than offsets the heat lost at night. However, even thermally efficient windows allow more heat to escape than does a well insulated wall: at night or other times when there is no solar gain, a window cools a room.

Operation and Maintenance

When windows are opened in winter, ice can form and prevent them from closing properly. Keep windows locked in winter, and when they are closed for long periods. This practice keeps the window square and warp-free, and reduces winter drafts.

Removing screens in winter prolongs their life and allows more light and warmth to enter the house. Shake the screens to clean them, or use a brush or hose. If the mesh on your screens has a black finish, do not rub the colour off with abrasive cleaning. (The black colour helps make the screen seem more transparent.)

Some skylights open or have a small ventilation flap. If the hardware is hard to reach, a special pole is usually provided. Close the skylight or flap when rain is expected, and with the approach of winter.

Once a year, clean the dust, debris and insects off sliders, hardware and other operating parts between the opening unit and the outside frame.

To fight mold and mildew, clean the inside wood finishes on windows regularly and wipe up any condensation that collects at the bottom edge of the glass. See *Troubleshooting*, if you see that condensation is forming.

Paint or finish on wooden windows protects the wood from water and sun damage. Repaint or refinish as soon as the surface begins to crack or bubble.



Paint can make windows jam. Do not paint weatherstripping; do not paint windows when they are shut; and do not paint surfaces that slide over each other when the window is being opened and closed.

Windows

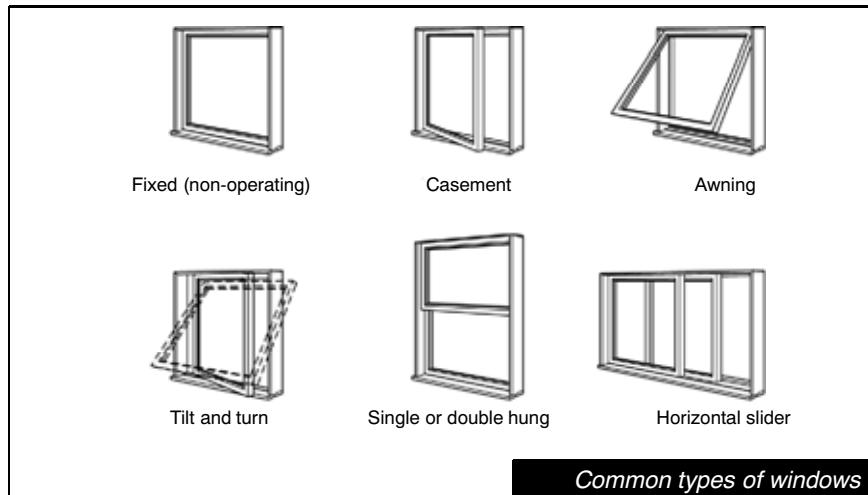

Builder's or Homeowner's Notes

Information on type of windows (double-glazed, triple-glazed, Low-E, etc.)

Information on warranties

PART TWO

INTERIOR FINISHES



GENERAL INFORMATION

Additional Tips

The builder may have left some surplus finishing materials (e.g., paint, wallpaper or tiles) in the house, and you can use these for future repairs. Be aware, however, that there is usually some fading or discolouration of materials in a house over time. Even with the original materials, you may not get a perfect match. If you have to buy new materials for a repair, perfect matching is even less likely, as dye lots tend to change with each batch of materials that a manufacturer makes.

-  Properly label any materials left over after repairs or renovation, and seal them to avoid off-gassing.

Overview

“Interior finishes” are the finished surfaces of the floors, walls and ceilings of your house. The flooring in a new house is usually a combination of two or more materials chosen from among the following: hardwood flooring; carpeting; resilient flooring (e.g., cushion flooring); and stone or ceramic tile.

Most walls in a new house are finished with *Drywall* (page 96) which may be painted or wallpapered. Ceilings are usually finished in drywall as well, perhaps with a textured finish trowelled or sprayed on. Other wall finishes include vinyl products, and wood, plywood or fibreboard panelling. In kitchens and bathrooms, stone or ceramic tiles are common.

Interior finishes include other elements, such as *Countertops and Cabinets* (page 99) and their associated hardware (e.g., handles), with the hardware being typically plated and lacquered with a decorative finish.

Caulking is an important complement to many of the interior finishes in your house. Latex caulking fills all the cracks between drywall and woodwork at doors, windows and baseboards throughout the house. Waterproof caulking (e.g., silicone) seals the joints around taps, bathtubs and plumbing fixtures, where water can be expected to sit.

-  See *Caulking* (page 71) for general information on caulking; and *Sinks, Bathtubs and Shower Enclosures* (page 157) for information on plumbing fixture finishes and caulking.

Care and Maintenance

To protect your floors from denting, scratching and tearing, put glides or rests under furniture and appliances. Do not drag or drop heavy objects on the floor. Narrow high-heeled shoes can also damage your floors.

The wear and tear on your flooring will be highest where the traffic is heaviest; however, efforts to keep these areas clean will prolong the life of flooring. Area rugs and loose runners are also recommended, with non-slip underpads beneath them. Use plastic or metal edge strips to protect the juncture of different types of flooring (e.g., where carpeting meets hardwood).

-  Hardwood, tile and smooth, resilient floorings can be slippery, especially when wet or snowy. Be careful when wearing house slippers or smooth-soled shoes.

General Information

☉ For information on squeaky floors, see *The First Year* (page 30). Be careful how you attach pictures, shelving and other objects to walls. Most kinds of sticky tape pull off some paint with them when removed. Picture hangers are best, as you can easily fill the small hole they leave behind. However, do not drive nails through the *Drywall* (page 96) or other interior finishes on the exterior (outside) walls: you may inadvertently puncture the vapour barrier and allow moisture from inside the house to penetrate the structure.

Clean hardware with a soft cloth. Over time the finish on the hardware will begin to wear. This will not harm the hardware, but if you want it to look new, polish it with a metal polish and relacquer (*Doors*, page 81).

Steel railings and other metal surfaces will rust if they are scratched and chipped: repaint them immediately.

Builder's or Homeowner's Notes

HARDWOOD FLOORS

Troubleshooting

Slight roughness of floor surface: This is not uncommon for a floor finished with a penetrating sealer: one or two applications of wax should smooth it out.

Chipped polyurethane finish: Spot refinish small areas where the polyurethane is chipped. If the floor is discoloured, rub it gently with fine-grade steel wool or sandpaper before applying the polyurethane.

Water stain on a floor finished with penetrating sealer: To remove a light-coloured water stain, rub gently with No. 2 steel wool until the stain disappears, then apply wax.

Grey discolouration along joints: Water has been seeping in at the joints. Identify and remove the source of water, or at least prevent it from reaching the floorboards.

Excessively large cracks between some floorboards: Concentrated heat in an area (e.g., from a heat vent) can dry the flooring and cause it to contract. If the heat is coming from below the flooring, insulate the floor over the heat source. However, be careful in doing so to maintain proper ventilation for combustion equipment.

Description

The hardwood floors may be made of:

- solid wood strips (planks);
- parquet (strips of wood arranged in a checkerboard pattern on small plywood panels or a mesh backing); or
- laminated panels (several layers of wood, glued together).

A finish protects the floor from dirt, scratches and moisture. Floors may be finished with a “no-wax” surface, usually polyurethane or with a penetrating sealer (oil).

Before being finished, hardwood floors are sometimes stained to add colour.

Care and Maintenance

Hardwood is a durable flooring material, which, if cared for properly, can last a lifetime. Regularly sweep or vacuum dirt and grit from the floor, then clean it with a damp mop. Use a mild detergent, if necessary, but avoid harsh detergents or large quantities of water, as these may harm the finish or wood. Never leave water standing on your wood floors. (Standing water is especially likely to go unnoticed under fixtures, appliances or any other areas where condensation, dripping or leaking may occur.) Constant dampness will eventually discolour the floor.

If your wood floor is finished with a penetrating sealer, you should wax the floor at least once a year. Use a purpose-made “spirit” wax, either liquid or paste. Apply the wax, allow it to dry, then buff with an electric polisher (available from an equipment rental outlet). Make sure the room is well ventilated when you apply dry wax, which usually contains toxic solvents. Alternatively, use a “self-polishing” liquid wax, one specifically made for use on hardwood floors. Surface-finished hardwood floors do not need waxing, though a cleaner specially formulated for the finish will restore the shine.

Refinishing typically involves sanding the whole floor to remove blemishes, followed by the application of two to three coats of polyurethane or an equivalent finish. Depending on the care taken to protect your floors from wear and tear, the finish will last anywhere from five to twenty years. You can usually refinish hardwood several times before you have to replace it.

Hardwood Floors

Additional Tips

To restore the appearance of a dulled or lightly scratched floor, “screening” — which involves using an attachment on the floor polisher to scuff the floor surface lightly — is an alternative to complete refinishing. Screening the floor every few years may reduce the need for full refinishing, with the result that the floor lasts longer. Alternatively, roughen the floor surface with steel wool and apply a fresh coat of finish (though this does not work if wax has ever been applied to the floor).

Wood floors may tend to shrink somewhat in the months after construction, as the wood adjusts to conditions in the house. Seasonal changes will also affect wood, and its natural water content will vary with the humidity in the house. The following occurrences are normal:

- minor gaps between the boards in dry conditions;
- the swelling of boards in conditions of high humidity and a slightly corrugated appearance when the floor is viewed in the direction of a light source; and
- cracking or popping sounds from parquet flooring, as it expands and contracts.

Although your floor will adjust easily to seasonal changes in humidity, long periods of high humidity (*The Environment in Your House*, page 17), or too much direct exposure to water, can buckle or stain the floor.

Builder's or Homeowner's Notes

Type of hardwood flooring (maple, cherry, oak, etc.) Details of stain and finish.

RESILIENT FLOORING

Troubleshooting

Curled tile: Cover the tile with an old cloth or a double thickness of aluminium foil, then heat it carefully with a warm iron: this restores flexibility to the tile and softens the old adhesive. Lift the corner of the tile gently to avoid tearing. Scrape off the old adhesive from the tile's underside and apply a thin coat of flooring adhesive, available at hardware stores. Press the tile firmly back into place and use a rolling pin to firm it down. Then, while the glue sets, weight the tile with at least 10 kg (20 lbs.); try a large book or a board with bricks or a pail of water on it.

Minor scratches: Rub the scratch lengthwise with the rim of a large coin or rub in a small amount of paste wax. If the scratch is still visible, lay a double thickness of aluminium foil over the scratch and heat carefully with a warm iron.

Tears or holes: Repair minor damage quickly to prevent the problem from getting worse. For vinyl flooring, wipe the area clean, then use a vinyl floor seam sealer to glue the surface material back together. For other types of flooring, use a utility knife to scrape shavings from a spare piece of flooring, then mix the scrapings with a small quantity of clear nail polish. Put masking tape around the damaged area and fill the tear or hole with the "putty" you made from shavings. Lay foil on top of the tear, then press with a warm iron to melt the shavings. Wait for an hour or more, remove the tape, and buff the repaired surface lightly with No. 00 steel wool.

Description

"Resilient flooring" describes manufactured sheet or tile flooring, usually with a pattern printed on the surface. Resilient flooring may be:

- cushion (sheet) flooring (a flexible sheet comprising a thin layer of vinyl over a spongy backing);
- vinyl composition tile (thick, rigid tile);
- linoleum sheet or tile (a product made from linseed oil and fillers); or
- rubber sheet or tile.

Care and Maintenance

Follow this basic cleaning routine for resilient flooring:

- Remove loose dirt frequently (daily or at least weekly) with a broom, mop or vacuum.
- For full washing, sponge-mop using lukewarm water and a mild detergent or, for high-gloss flooring, a floor-cleaning solution.
- Between full washings, wipe soiled areas with a damp cloth, mop or sponge.
- Clean up spills quickly. If a spill dries, wipe it with a damp cloth, mop or sponge. Use a mild (e.g., dishwashing) detergent or, if necessary, a floor-cleaning solution.
- To remove difficult stains, use a damp cloth and gentle scouring powder, or a mixture of one part bleach to ten parts water. Rinse the area well after cleaning.
- To restore a dull finish, use a clean sponge-mop to apply a liquid floor finish formulated for your flooring type.
- You can use an electric floor polisher (available from equipment rental outlets) to buff flooring after cleaning or applying a liquid finish.



Do not buff high-gloss floors or use scouring powder or any other abrasives.

Avoid using too much water when cleaning, as this can seep below the flooring and loosen the adhesive or cause the subfloor to buckle. Also

Troubleshooting Cont'd.

“Blisters”: Heat or water seeping in under the flooring can cause it to blister. Before you repair the damage, make sure you have removed the cause. Use a utility knife to slit the blister lengthwise, extending the cut about 10 mm (3/8 in.) beyond the blister at each end. Cut along the line of the pattern, if possible, to make the slit less noticeable. Lay down a piece of aluminium foil, then use a warm iron to soften the flooring around the cut. Insert a putty knife loaded with flooring adhesive into the cut and smear adhesive on the underside of the blistered area. Press the blister flat, wipe up the excess adhesive and weight the area down (see *Curled tile*) until the adhesive has set.

Extensive damage: You will have to replace the whole tile or section of flooring. This is not hard. Consult a do-it-yourself renovation manual.

avoid harsh cleaners, which can discolour and age the material. Do not use abrasive materials such as steel wool.

Some denting by furniture and appliances is normal. However, use glides or furniture rests to minimize the damage. Do not use rubber protectors on vinyl flooring, as rubber can stain vinyl.

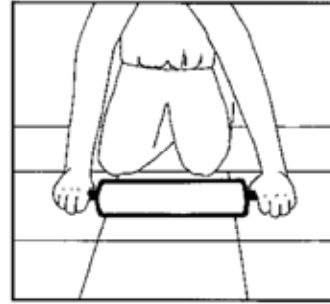
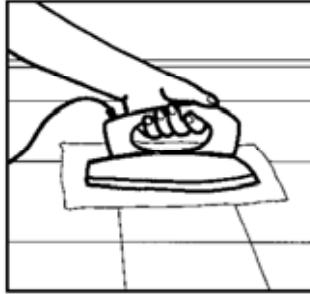

Repairing a curled tile

Builder's or Homeowner's Notes

STONE OR CERAMIC TILE

Troubleshooting

Damaged tiles: Usually, the builder will replace tiles that crack within the first year because of settlement or shrinkage in the frame; however, the builder does not take responsibility for breakage due to other causes. Variations in manufacturer dye lots mean that, in making repairs, it is not always possible to get a perfect match with the original tiles. your builder will not replace whole floors to avoid a slight mismatch.

Deteriorating grout: Hairline cracks at joints in the tiling are common and are not a problem. However, if the grout between the tiles chips and falls out, it should be patched or replaced, especially where the floor is frequently exposed to water (e.g., in entranceways and bathrooms). Remove the old grout to a minimum depth of 2 mm (1/8 in.) and replace with new matching grout. Use caulking instead of grout between tiles and fixtures (e.g., toilets) or where tiles meet the wall: caulking is flexible and seals between different materials.

Additional Tips

Apply grout sealer (available from tile suppliers or hardware stores) to grouted joints: it protects them from staining.

-  Grout, tile adhesives and sealers contain chemicals that may be risky for people with allergies or environmental sensitivities. When shopping for materials, look for health alerts on packaging and ventilate the work area well (*The Environment in Your House*, page 17).

Description

Entranceways are often floored with stone or ceramic tile, and ceramic tile is common in bathrooms. Tiles may also appear in other rooms, such as the kitchen, family room and sunroom. Tile may be made of:

- quarry tile (an unglazed ceramic tile);
- glazed ceramic tile;
- slate tile; or
- marble tile.

Grout fills the joints between tiles. Flexible caulking seals the junctions between walls, floors and fixtures.

Care and Maintenance

Clean your tiles with mild soap and water, but avoid using too much water.

Do not drop heavy objects that might crack the tiles.

A purpose-made tile sealer is used to seal quarry, slate or marble tiles. Reseal the tile periodically, usually every two to five years or as directed on the package of sealer, which is available from tile suppliers or hardware stores.

Remove and replace caulking periodically. Choose flexible, non-toxic caulking that is compatible with the adjacent materials and will cure within a few hours (*Caulking*, page 71; *Bathroom Sinks, Tubs and Shower Enclosures*, page 157).

Builder's or Homeowner's Notes

CARPETING

Troubleshooting

Spills and stains: To remove spills, first blot up the stain with a paper towel or clean cloth. (If a thick substance has been spilled, gently scoop up as much as possible with a knife or spatula.) Avoid rubbing. Next apply a cleaner. Soda water or a detergent solution are good at removing stains left by water-soluble substances (e.g., juice, coffee, tea, blood and ketchup), or you can use a general purpose foam or powdered carpet cleaner, available at supermarkets. You may need a commercial spot-removing solution, available from carpet-cleaning stores, to deal with oily spills. If any stains remain after treatment, call a carpet cleaner for advice.

- ⦿ Black streaking occasionally occurs on light carpets. This is caused by carbon, but the sources of carbon have not been well-defined. This streaking cannot be removed.

Odours from the carpet: To deodorize a carpet, sprinkle it liberally with baking soda, leave the powder on for at least half an hour and then vacuum.

Description

The wall-to-wall carpeting in your new house is made of either durable synthetic yarn, usually nylon, polyester or olefin, or wool fibre.

In making a carpet, the manufacturer stitches the yarn in loops. If the loops are cut, the product is called a “cut pile carpet.” Some carpets feature a mix of loop and cut.

Care and Maintenance

If you want your carpets to look good and last long, you need to care for them. Unless they are cleaned thoroughly from time to time, carpets tend to accumulate dust, dust mites, molds, bacteria and other materials, which can affect the health of people living in your household (*The Environment in Your House*, page 17).

Regardless of the fibre and pile type, there is one basic cleaning routine for carpets, as follows:

- Clean up spills immediately to prevent spots and staining.
- Remove dirt and lint frequently from areas of heavy traffic.
- Vacuum weekly to remove embedded dirt.
- Have the carpet professionally cleaned every year or two to improve its appearance and to extend its life.

The swinging of doors and the repetitive movement of furniture (e.g., rockers) can wear out a carpet. Sand or plane the bottom of any *Door* (page 81) that is rubbing against a carpet.

Additional Tips

- For some makes of vacuum cleaner, there are micro-lined filter bags available. These bags trap very fine particles and reduce the amount of dust in the air during vacuuming.
- Carpet-cleaning chemicals and soil repellent treatments can affect air quality, and steam cleaning can foster the growth of molds, if the carpet is slow to dry. If your carpet-cleaning company uses a conventional process, make sure the house is well ventilated during the work. Some carpet-cleaning companies offer alternative approaches that eliminate the use of soap, detergent and fragrance.

Builder's or Homeowner's Notes

DRYWALL (WALLBOARD)

Troubleshooting

Minor cracks and “bumps” in the drywall: See Care and Maintenance.

Gaps or cracks in drywall where walls meet the top floor ceiling:

Seasonal changes in the amount of moisture in the wood and temperature differences between the ceiling and attic cause truss uplifts (i.e., the bowing of roof trusses), and this in turn causes gaps in the drywall. Keep humid air from the house out of the attic (*Roofing*, page 58). In attaching drywall, your builder has minimized the risk of damage from truss uplift; but since little can be done to prevent minor changes in the shape of roof trusses, small cracks are likely to appear. Fill these cracks and gaps with drywall compound, available at hardware stores. If the problem is severe (the gap greater than 2 mm or 1/16 in.), contact your builder.

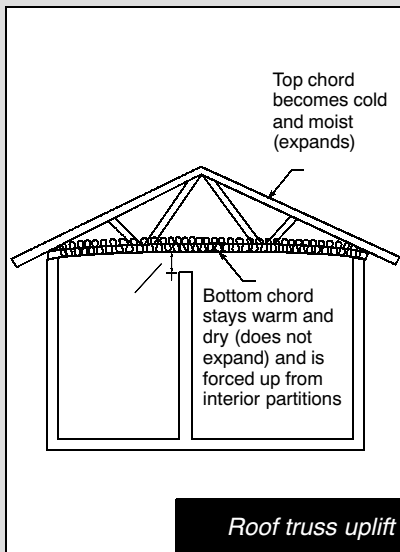

Leaks or water staining on the inside surface of the wall: Water may be penetrating the roof or siding. Check *Roofing* (page 58) for damage. Make sure that no ice dams have formed and that the

Description

Drywall (or wallboard) is made of a calcium-based mineral called gypsum, which is sandwiched between two layers of paper. Drywall comes in panels that are nailed or screwed to wall studs and ceiling joists. Drywall compound fills the joints between panels and is sanded to a smooth finish. The surface is then painted or covered in another way.

Care and Maintenance

Drywall is an inexpensive and versatile material. While moisture or a blow from a sharp or heavy object can injure drywall, it is easy to repair and refinish. Use spackling or drywall compound, available at hardware or paint stores, to patch small cracks or holes in drywall.

For the first year or two after construction, the wood framing in the walls of your house will be drying out (*The First Year*, page 30). During this time, normal shrinkage and minor warping in the wood causes some of the nails or screws holding the drywall to “pop”. These nails or screws show up as raised plugs of drywall, or as localized cracking. Such pops and cracks are common, especially at bay windows, in cathedral ceilings, and around stairway openings. The builder can reduce the incidence of pops by using dry wood, but even the highest quality materials and construction practices cannot completely eliminate the phenomenon. It is easy to repair nail pops, as follows:

- Drive a new drywall nail or screw through the drywall into the stud at a distance of 50 mm (2 in.) above or below the popped nail.
- Carefully scrape away loose material around the popped nail and hammer it back into the stud.

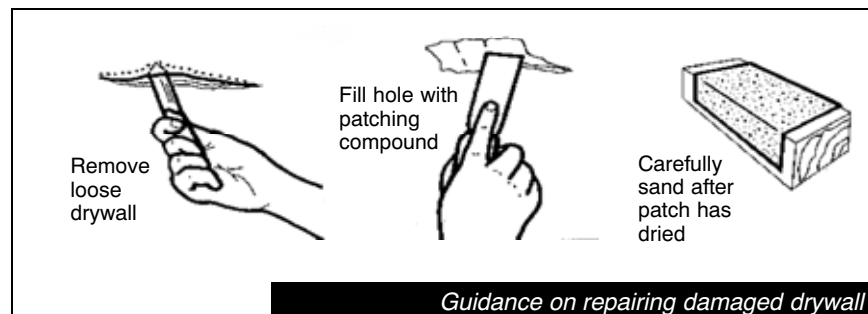

Troubleshooting Cont'd.

Eavestroughs (page 69) are intact and working. Examine the *Exterior Finish* (page 57), and caulk any visible cracks. Check the caulking itself for signs of deterioration and replace it, if necessary (*Caulking*, page 71). Consider also whether humidity from the house is penetrating the wall or attic (*Roofing*, page 58; *The Environment in Your House*, page 17). If you cannot identify the source of the water, or if the repairs within your scope have not corrected the problem, contact your builder or a building contractor. It is important to repair water-related problems immediately, as moisture will damage and reduce the effectiveness of insulation and cause mildew and wood rot.

Additional Tips

For larger holes in the drywall, apply a thin coat of drywall compound, then criss-cross the area with drywall tape. Coat the tape with compound and allow it to dry for 24 hours. Apply another layer of compound, if needed. Sand with fine-grain sandpaper, taking care not to damage the surrounding drywall.

Decorative medallions around ceiling fixtures and ceiling mouldings are often made of moulded plaster. If the plaster chips or cracks, use a plaster compound to repair it.

- "Lite" drywall compounds, though more expensive, are much easier for the non-specialist to apply and to sand to a smooth finish.
- Choose paints marked with the EcoLogo (*The Environment in Your House*, page 17), or ones that your dealer assures you do not release harmful gases.

- Smooth the area with sandpaper and apply drywall compound (available at hardware stores) in three coats over the old and new nails.
- Allow each coat to dry thoroughly before applying the next. Sand to an even finish.
- In painting over patched areas, some sign of the patch is likely to remain. Even if the same paint lot is used, perfect blending is hard to achieve. It is best, therefore, to leave drywall pops alone until the house has completely finished drying out (two to three years), then repair them before repainting or redecorating.

Hang pictures with special picture hanger nails and hooks, available at hardware or framing stores. Place small self-adhesive pads, available from hardware stores, at the back of metal-framed pictures to prevent them from damaging the wall finish. Refer to the illustration for guidance on fastening heavier items to drywall.

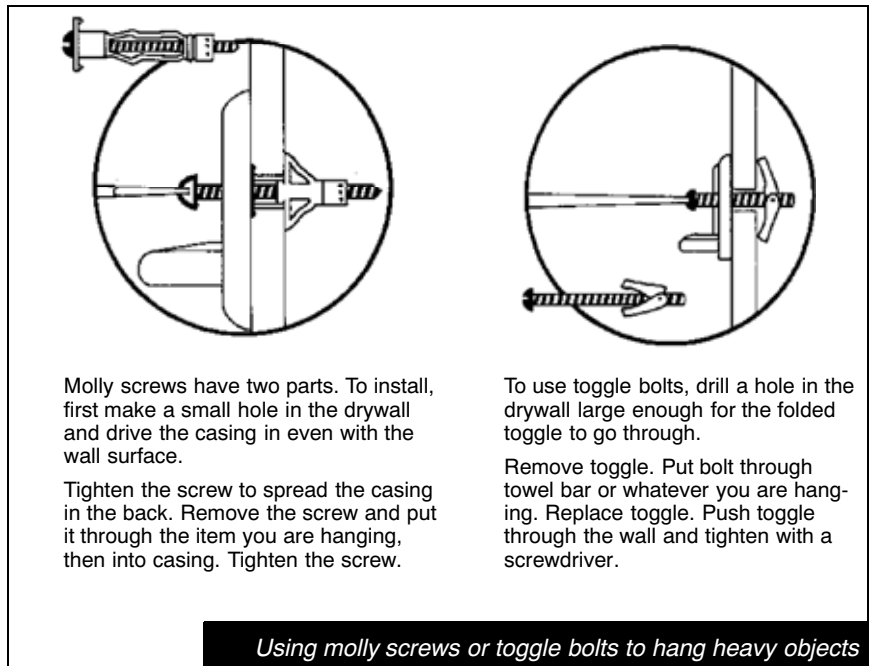

Molly screws have two parts. To install, first make a small hole in the drywall and drive the casing in even with the wall surface.

Tighten the screw to spread the casing. Remove the screw and put it through the item you are hanging, then into casing. Tighten the screw.

To use toggle bolts, drill a hole in the drywall large enough for the folded toggle to go through.

Remove toggle. Put bolt through towel bar or whatever you are hanging. Replace toggle. Push toggle through the wall and tighten with a screwdriver.

Using molly screws or toggle bolts to hang heavy objects

- Remember, there is a vapour barrier behind the drywall on exterior walls and above the ceiling of the top floor: avoid using long nails or screws that would puncture it (*The Whole House, An Overview*, page 13). If you do puncture the vapour barrier, caulk around the nail or screw (*General Information*, page 87).

Drywall (Wallboard)

**Builder's or
Homeowner's Notes**

Indicate your policy on repair of drywall "pops" and cracks

COUNTERTOPS AND CABINETS

Troubleshooting

Scratches: Use a putty stick to fill small scratches on cabinet doors. Colour-matched putty sticks are available from paint stores or possibly from the manufacturer of the cabinet. You can sand solid plastic countertops if they are very damaged.

Cabinet door out of alignment: There are two sets of positioning screws on the hinges on most cabinet doors. They can be moved relative to each other to adjust the precise position of the door: one set adjusts the door from side to side, the other from top to bottom. Play with these screws to see how loosening one and tightening the other affect the way the door hangs. When you are satisfied with the door's position, tighten — but do not over-tighten — both sets of screws.

Cracks and gaps: Normal settlement of the house may cause the filler between the cabinets or countertops and the wall or floor to loosen during the first year or so after construction. Re-seal with a silicone caulking. Do this immediately for gaps that appear between sinks and the surrounding countertops (*Sinks, Tubs and Shower Enclosures*, page 157).

Additional Tips

If banging doors annoy you, place rubber self-adhering bumpers at the top, middle and bottom of cabinet doors — the part that makes contact with the door frame. These bumpers are available at hardware stores.

Description

The finishes for your kitchen and bathroom countertops may be plastic laminate, solid plastic, tile or stone.

The finishes for your kitchen and bathroom cabinets may be plastic laminate, high-gloss polyester or wood (solid, particleboard or plywood).

Care and Maintenance

The builder used durable materials for your countertops and cabinets. With proper care, as suggested below, they should continue to look good for many years.

- Do not put hot pots or pans from the stove directly on to the counter.
- Do not use the countertop as a cutting board.
- Wipe up all spills immediately.
- Wipe up excess water, especially around seams, sinks and at countertop edges, where water can get behind or underneath the finish and damage it.
- Make sure that dishes and so on are dry before you return them to the cabinet.
- Clean laminate and wooden doors, cabinet interiors and countertops with a damp soft cloth and, if necessary, a mild detergent (e.g., dishwashing liquid). Dry with a soft, dry cloth.
- Using a soft, dry cloth, clean high-gloss polyester doors with an ammonia-free window cleaner or a vinegar and water solution.
- For stubborn stains, use a household cleaner and rinse thoroughly with clean water.
- Do not use abrasive cleaners or steel wool.
- After cleaning naturally finished wood, apply a light coat of high-quality liquid or paste furniture wax. Avoid self-polishing waxes.
- After cleaning, polish countertops with lemon oil to give them a gloss.
- If a hinge is loose, tighten it promptly using the right screwdriver, before the damage gets any worse. (Refer to *Troubleshooting* for tips on adjusting a door on its hinge.)

**Builder's or
Homeowner's Notes**

Indicate the finishes for you kitchen and bathroom's countertops and cabinets:

PART TWO

HEATING, VENTILATION AND AIR CONDITIONING

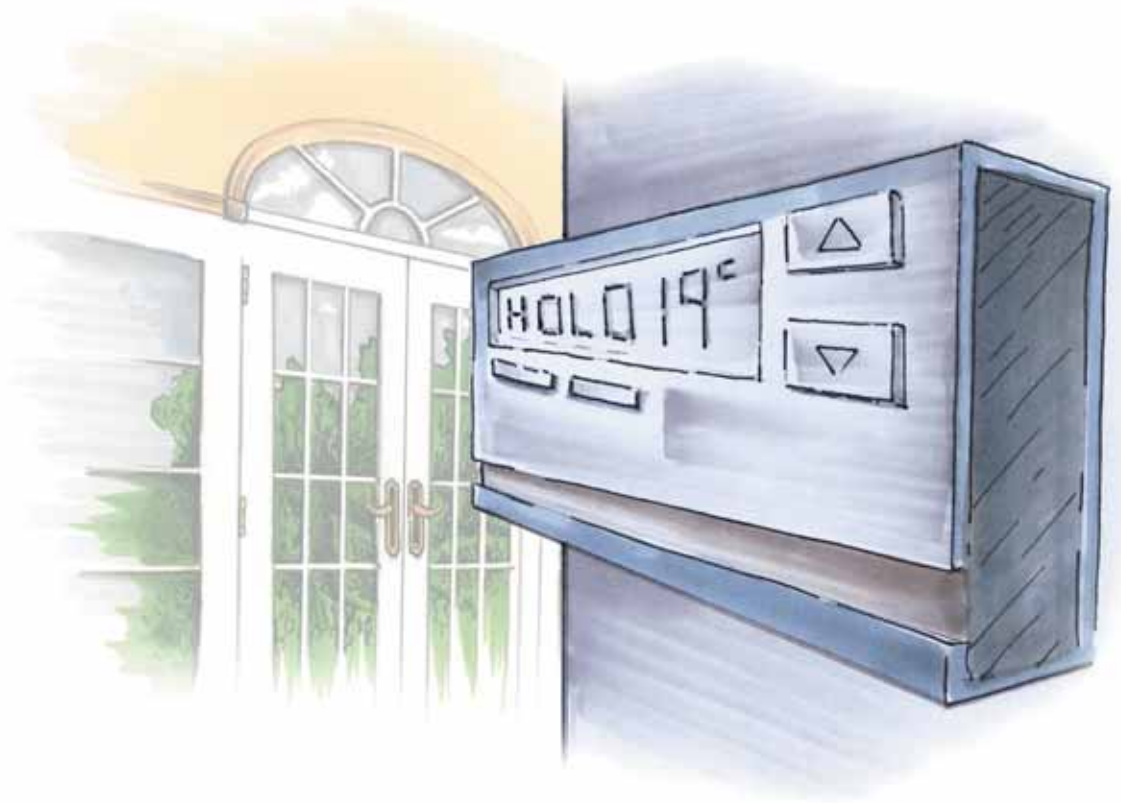

GENERAL INFORMATION

Troubleshooting

Noisy heating system ducts or pipes: The expansion of metal as it heats up, or contraction as it cools, can cause snapping, banging or cracking sounds in the ducts. Expansion and contraction are normal and will not affect the performance of the system. However, a heating and ventilation contractor may be able to reduce or eliminate the noise.

Stale smelling air: An increase in the number of occupants or level of activity in the household can affect air quality which, in turn, affects occupant health. Give serious attention to signs of inadequate ventilation. Use the ventilation system deliberately to exhaust stale air and bring in fresh air: for example, combat odours or humidity in kitchen and bathrooms by turning on the principal exhaust system (the switch is usually centrally located and should be marked “Ventilation Fan”) and/or the *Exhaust Fans* (page 134). If your house is equipped with a *Heat Recovery Ventilator* find out how to use it. *The Environment in Your House* (page 17) provides more information on stale air, its causes and cures.

- ⦿ Opening windows may bring in fresh air, but is not recommended as the main form of ventilation.

High levels of condensation: Air, if it is too humid, will condense on cold surfaces in the house (such as windows, mirrors and hard finishes). If condensation is visible in such areas, chances are that it is also occurring where you may not see it, but where it can do even more damage (as in the attic or inside the walls). *Condensation can lead to problems and should not be ignored.*

System Overview

The comfort and health of your household depend on the systems that heat your house in winter and ventilate it through the year. To regulate indoor temperatures in the summer, your house may also have a mechanical cooling system.

The *Heating System* or systems in your house convert one or more sources of energy (such as gas, oil, electricity, wood or solar) into heat. One or more *Thermostats* (page 132) control the amount of heat delivered or — in the case of central air conditioning — the amount of cool air. If a furnace heats your house, it distributes heat through a *Forced Air Duct System* (page 130). The cool air generated by a *Central Air Conditioning* unit is also distributed through this duct system.

“Ventilation” describes the process of getting rid of stale or humid air and replacing it with fresh air. Since today’s houses are constructed to be energy-efficient, air does not leak as freely in and out through cracks and gaps as it tends to in older homes. The creation of good ventilation in new houses, therefore, requires an active approach: at a minimum, air must be mechanically exhausted from the kitchen and bathrooms. This may be accomplished with direct-vent *Exhaust Fans* (page 134) in these locations and/or with a central (principal) exhaust system, with a *Heat Recovery Ventilator* now being the common ventilation device.

One or more fresh-air intakes—these are ducts running from the outside of the house through an exterior wall to the inside—make up the air that the ventilation system exhausts from the house. A hood, often labeled “INTAKE,” covers the duct opening at the outside wall.

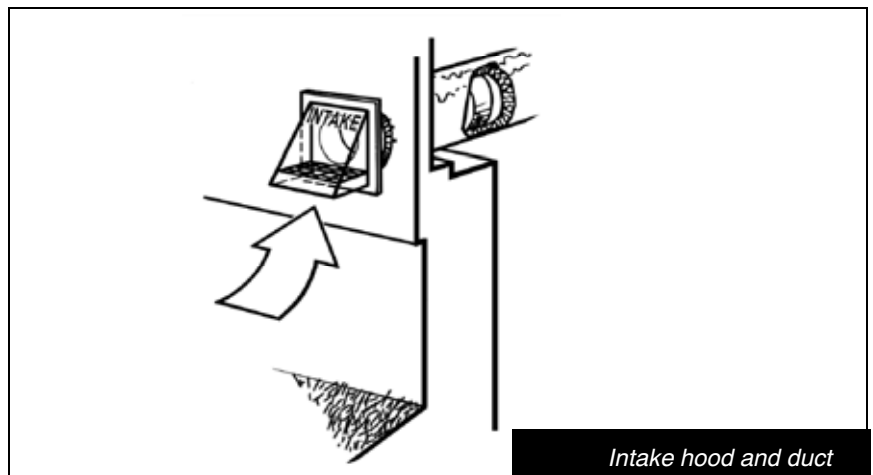

Intake hood and duct

General Information

Troubleshooting Cont'd.

Excess moisture: Many household activities — showering, cooking, air-drying laundry and even breathing — add moisture to the air in the house. Leaks or seepage into parts of the house such as the basement or crawl space also contribute to excess moisture. Removing humidity involves much the same process as improving air quality. Also take steps to control sources of humidity. *The Environment in Your House* (page 17) identifies the causes, signs and risks of humidity and outlines additional steps for controlling it.

 If your stove has a recirculating *exhaust fan* (page 134), this will not remove moisture.

In addition to fresh-air intakes for ventilation, one or more intakes may supply combustion air to your heating appliances. These ducts run directly from an outside wall into the combustion unit, or at least near it.



Operation and Maintenance

 Never block a fresh-air intake or any duct that runs through the wall of your house to the outside. In winter, keep these ducts clear of snow.

Your heating system will only generate heat when the temperature setting on the thermostat is higher than the temperature of your house. When you raise the setting, allow for the time it will take for the room to warm up. Do not over-set the temperature: this wastes energy and can cause discomfort. The same applies to your cooling system.

Builder's or Homeowner's Notes

Additional Tips

  The sun will affect the heating and cooling balance of your house. *Landscaping and Vegetation* (page 43) provides guidance on how to use window awnings and vegetation to screen out summer sun, while letting in winter sun. To minimize the heating load in summer, close windows and window coverings (blinds and curtains) during the heat of the day and open them during the night and early morning.

HEATING: GAS FURNACE

Troubleshooting

No heat: If there is no sign of activity from the furnace (e.g., vibration or combustion noise or air flow from the warm air grille) within five minutes of setting the thermostat at a higher temperature, take the following steps:

- Ensure that the *Thermostat* control (page 132) is not set to “OFF” or “AIR CONDITIONING.”
- Check that the emergency on/off switch has not been accidentally turned off.
- At the main electrical panel (*General Information*, page 167), check that the breaker labelled “FURNACE” or “HEATING” is set correctly. Switch the breaker to “OFF,” then back to “ON.”
- If a pilot light ignites the gas in the combustion chamber, check that it is on.
- If there is still no activity, call your fuel supplier or a furnace service company.

Furnace runs for a short time, then stops, but no air comes from the warm air grilles: If your furnace has a belt-driven fan (i.e., a rubber belt on the fan motor drives the fan), remove the lower panel on the furnace to check whether the belt has broken or come off the wheel. If the belt is not the problem, or if it is damaged but you cannot fix it, contact your gas utility or furnace service company.



Remember to turn off the power to your furnace at the emergency switch or at the electrical panel (*General Information*, page 167) before opening the access panel.

Noisy furnace: If your furnace has a belt-driven fan, a loose or slipping belt may make a high-pitched squealing noise. See the above *Troubleshooting* tip for instructions.

Description

Your furnace is both the heat source and distribution centre for your heating system. The natural gas that fuels the furnace is piped to the house from an underground network of gas supply pipes. The gas supply pipe connects to equipment that is owned and operated by the gas utility and mounted on the exterior wall of your house. This equipment includes a shut-off valve, a regulator to reduce the pressure to levels safe enough for household use, and a meter to measure gas consumption. Inside the house, the gas supply pipe connects to the furnace and possibly to other gas appliances.

Your furnace has four key components:

- **Combustion chamber:** Here the natural gas, lit by electric ignition or a pilot light, burns to create heat.
- **Heat exchanger:** A series of metal plates or tubes transfer heat from the combustion chamber to the household air supply.
- **Blower or circulating fan:** The fan circulates heated air through the house’s duct system (*Forced Air Duct System*, page 130), which is why the system is called a “forced air” heating system. Furnaces may be supplied with a three speed fan for ventilation (low speed), heating (medium speed) and air conditioning (high speed).
- **Filter:** The filter screens dust from the air that moves through the furnace. Your furnace has one of the following:
 - a standard disposable filter mounted in a paper sleeve;
 - a standard reusable filter, typically made from spun fibreglass or metal, possibly with rods for rigidity; or
 - an electrostatic air filter, which electrically charges dust particles passing through the furnace, then removes them by static electric attraction.

The duct that provides combustion air to the furnace usually enters the house at the top of the basement wall and hangs down inside the wall. Your furnace is designed so that gases created during combustion never mix with the household air. They are vented directly to the outside, either by a fan (an “induced draft fan”) that blows them through a duct at the side of the house, or through a chimney. A safety device shuts the furnace down if a powered venting system fails. In high efficiency furnaces, which have relatively cool exhaust, the water vapour in the combustion gases condenses and usually runs into a floor drain or is pumped to a laundry tub.

Troubleshooting Cont'd.

No heat from a particular grille:

Check that the grille and the duct damper are open (*Forced Air Duct System*, page 130). If that is not the problem, a section of the duct may be blocked or disconnected. Contact your builder or a heating contractor.

Unbalanced amount of heat to various rooms:

See the *Troubleshooting* section of *Forced Air Duct System*, page 130.

Bad odours from the grilles:

Something may be rotting in a duct (*Forced Air Duct System*, page 130).

ⓘ If you smell gas, first check to see if any of your gas appliances have been accidentally turned on. If this is not the source of the gas, open the windows and doors to ventilate the house and leave the premises immediately. Do not turn on any electrical lights or appliances, or generate any sparks or flames. Call your gas utility from a neighbour's house. (See *A Safe and Secure Home*, page 26, for information on reducing the risk of gas leaks and responding to them.)

Headaches, dizziness, sleepiness or nausea:

Odourless combustion gases, if they enter the house's air supply, may cause these symptoms. If gas is suspected, open windows, shut off the furnace and call your gas utility or furnace service company. Seek immediate medical attention for any symptoms associated with combustion gases.

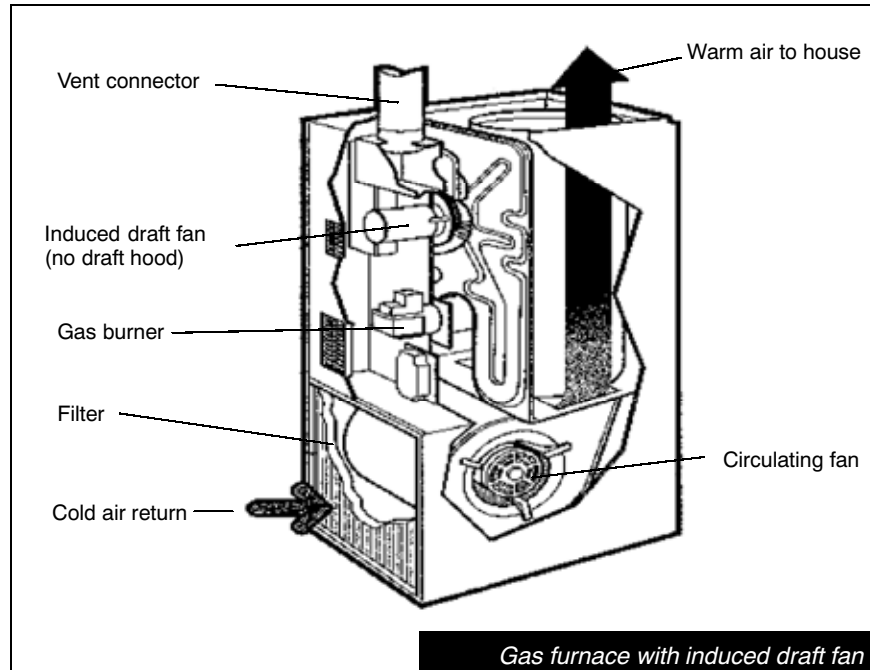

Gas furnace with induced draft fan

An emergency on-off switch for the furnace is usually located on the basement ceiling or wall near the stairs. This looks like a light switch but should be labelled “FURNACE.”

A built-in humidifier, which adds moisture to air passing through the furnace, may have been added to your heating system.

Operation and Maintenance

It takes a few minutes for the fan to come on after you turn up the setting on a *Thermostat* (page 132). Do not set the thermostat higher than the temperature you want: this will not result in faster heating.

To avoid blocking the flow of air around the furnace and to prevent fires, do not store anything — especially flammable or toxic household chemicals — against or around the furnace. An uncluttered area around the furnace also makes access for maintenance and repair easy.

A dirty filter reduces the efficiency of your heating system. Check the furnace filter at least every two months during the heating season and change or clean it as necessary. Remove the old filter, which may be found either in a slot on the furnace or behind a removable access panel. If the furnace is fitted with a disposable filter, replace it with a new filter of the same size, available from a hardware store. If the filter is reusable, vacuum the dirty side, using the vacuum's hand attachment; some filters can then be washed in soapy water and rinsed. If you have an

Additional Tips

- Install a carbon monoxide (CO) detector close to the furnace and another in the bedroom area: these will detect combustion gases that are not being properly exhausted, and signal the danger at an early stage.

You can use the furnace fan to help cool your house! On hot days, close the windows and window shades and turn the fan setting to "ON" at the *Thermostat* (page 132) or on the furnace; the fan will circulate cool basement air through the house. Make sure the heat switch is set to "OFF" or "COOL." On cool, dry nights, leave the furnace fan off and cool the house by opening windows. This will allow the relatively low temperatures of the surrounding earth to cool the basement again. Do not do this in humid weather, however, as it can lead to basement condensation and mold.

- Save energy while away on vacation! Turn your heat down to 10°C (50°F).

electrostatic air filter, consult the manufacturer's instructions about regular cleaning.

- Turn off the power to the furnace at the emergency on/off switch or at the electrical panel (*General Information*, page 167), before opening the furnace access panel.
- If you have a standard filter, consider replacing it with a premium (pleated) filter as this type of filter will do a better job of maintaining indoor air quality. Though the premium filter is not reusable, it may last as much as a year. Before buying such a filter, however, check with your furnace company to make sure this type is compatible with your furnace.

Have the furnace professionally serviced every one or two years, preferably before the heating season begins. Your utility will probably have a service program or can recommend a reliable furnace service company. Servicing usually includes checking the safety controls, the vent duct or chimney venting fan, the fresh-air intake, the heat exchanger, the fan motor, the filter and the supply line.

If your furnace has a built-in humidifier, it should be cleaned at least twice during the heating season, as specified in the manufacturer's instructions. Cleaning keeps the humidifier functioning well, and reduces the risk of mold growth. Turn off and drain the humidifier for the summer.

- Avoid setting the humidity level too high. You can use a hygrometer — a device that measures air humidity — to determine when to turn on the humidifier. (See *The Environment in Your House*, page 17.)

Builder's or Homeowner's Notes

Your furnace has a _____ speed circulating fan.

For More Information

Heating with Gas. Natural Resources Canada, Home Heating and Cooling Series #3.

HEATING: OIL FURNACE

Troubleshooting

No heat: If there is no sign of activity from the furnace (e.g., vibration or combustion noise or air flow from the warm air grille) within five minutes of setting the thermostat at a higher temperature, take the following steps:

- Ensure that the *Thermostat* control (page 132) is not set to “OFF” or “AIR CONDITIONING.”
- Check that the emergency on/off switch has not been accidentally turned off.
- At the main electrical panel (*General Information*, page 167), check that the breaker labelled “FURNACE” or “HEATING” is set correctly. Switch the breaker to “OFF,” then back to “ON.”
- If a pilot light ignites the gas in the combustion chamber, check that it is on.
- If there is still no activity, call your fuel supplier or a furnace service company.

Furnace runs for a short time, then stops, but no air comes from the warm air grilles: If your furnace has a belt-driven fan (i.e., a rubber belt drives the fan motor), remove the lower panel on the furnace to check whether the belt has broken or come off the wheel. If the belt is not the problem, or if it is damaged but you cannot fix it, contact your furnace service company.



Remember to turn off the power to your furnace at the emergency switch or electrical panel (*General Information*, page 167) before opening the access panel.

No heat from a particular grille: Check that the grille and the duct damper are open (*Forced Air Duct System*, page 130). If that is not the problem, a section of the duct may be blocked or disconnected. Contact your builder or a heating contractor.

Description

Your oil furnace is both the heat source and distribution centre for your heating system. A tanker truck supplies oil to a large storage tank, usually located in the basement. A copper fuel line, usually buried in the basement floor, runs from the oil tank to the furnace. A gauge on the top of the tank tells you how much oil is in the tank.

Your furnace has four key components:

- **Combustion chamber:** Here the oil burns to create heat. A burner located on the side of the furnace near the floor ignites the heating oil in the chamber.
- **Heat exchange:** A series of metal plates or tubes transfer heat from the combustion chamber to the household air supply.
- **Blower or circulating fan:** The fan circulates heated air through the house’s duct system (*Forced Air Duct System*, page 130), which is why the system is called a “forced air” heating system. Furnaces may be supplied with a three speed fan for ventilation (low speed), heating (medium speed) and air conditioning (high speed).
- **Filter:** The filter screens dust from the air that moves through the furnace. Your furnace has one of the following:
 - a standard disposable filter, mounted in a paper sleeve;
 - a standard reusable filter, typically made from spun fibreglass or metal, possibly with metal rods for rigidity; or
 - an electrostatic air filter, which electrically charges dust particles passing through the furnace, then removes them by static electric attraction.

The duct that provides combustion air to the furnace usually enters the house at the top of the basement wall and hangs down inside the wall. Your furnace is designed so that the gases created during combustion never mix with household air. Some new oil furnaces vent combustion gases directly out the side wall of the house. A safety device shuts the furnace down if the venting system fails.

An emergency on-off switch for the furnace is usually located on the basement ceiling or wall near the stairs. This switch looks like a light switch but should be labelled “FURNACE.”

A built-in humidifier, which adds moisture to air as it passes through the furnace, may have been added to your heating system.

**Troubleshooting
Cont'd.**

Noisy furnace: If your furnace has a belt-driven fan, a loose or slipping belt may make a high-pitched squealing noise. See the *Troubleshooting* tips for instructions.

Bad odours from the grilles: If a fuel-like smell is emanating from the grille, combustion gases may be entering your house air supply. Occupants may notice headaches, dizziness, sleepiness or nausea. Call your fuel supplier or furnace service company without delay and seek immediate medical attention for any symptoms associated with combustion gases. If the smell is more “earthy,” something may be rotting in a duct (*Forced Air Duct System*, page 130).

Unbalanced amount of heat to various rooms: See the *Troubleshooting* section of the *Forced Air Duct System* on page 130.

Additional Tips

When the tank is only partly full, moisture can condense on the exposed sides of the tank and cause them to rust. To reduce the risk of rusting, top up the oil in your tank at the end of the heating season.

- 📍 Install a carbon monoxide (CO) detector close to the furnace and another in the bedroom area: these will detect combustion gases that are not being properly exhausted, and signal the danger at an early stage.

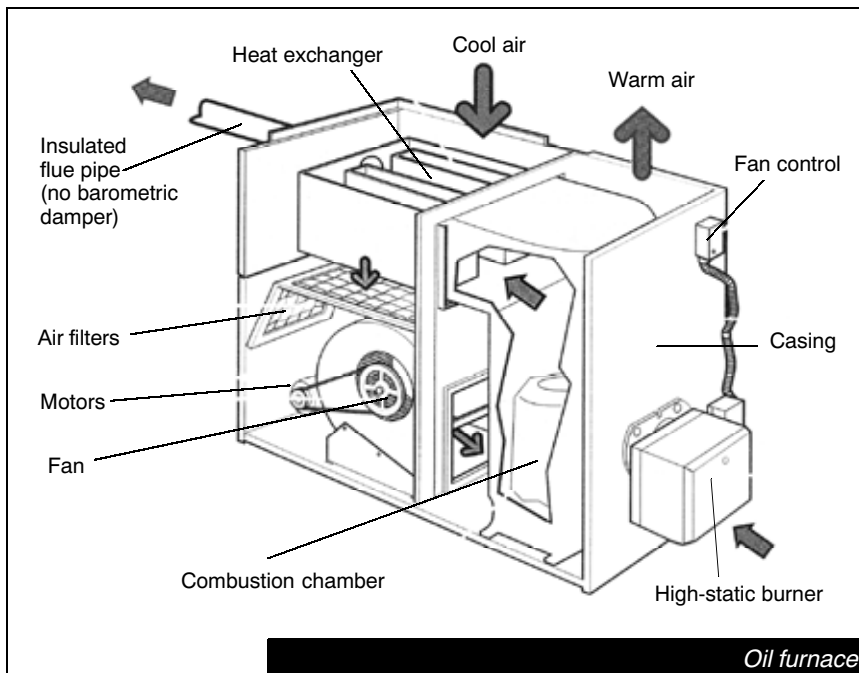

Oil furnace

Operation and Maintenance

It takes a few minutes for the fan to come on after you turn up the setting on a *Thermostat* (page 132). Do not set the thermostat higher than the temperature you want: this will not result in faster heating.

To avoid blocking the flow of air around the furnace and to prevent fires, do not store anything—especially flammable or toxic household chemicals—against or around the furnace. An uncluttered area around the furnace also makes access for maintenance and repair easy.

A dirty filter reduces the efficiency of your heating system. Check the furnace filter at least every two months during the heating season and change or clean it as necessary. Remove the old filter, which may be found either in a slot on the furnace or behind a removable access panel. If the furnace is fitted with a disposable filter, replace it with a new filter of the same size, available from a hardware store. If the filter is reusable, vacuum the dirty side, using the vacuum’s hand attachment; some filters can then be washed in soapy water and rinsed. If you have an electrostatic air filter, consult the manufacturer’s instructions on regular cleaning.

- 🔌 Turn off the power to the furnace at the emergency on/off switch or at the electrical panel (*General Information*, page 167) before opening the furnace access panel.

Additional Tips Cont'd.

You can use the furnace fan to help cool your house! On hot days, close the windows and window shades, and turn the fan setting to "ON" at the *Thermostat* (page 132) or on the furnace; the fan will circulate cool basement air through the house. Make sure the heat switch is set to "OFF" or "COOL." On cool, dry nights, leave the furnace fan off and cool the house by opening windows. This will allow the relatively low temperatures of the surrounding earth to cool the basement again.

Do not do this in humid weather, however, as it can lead to basement condensation and mold.

- 🌳 ⚡ Save energy while away on vacation! Turn your heat down to 10°C (50°F).

- ♥ If you have a standard filter, consider replacing it with a premium (pleated) filter as this type of filter will do a better job of maintaining indoor air quality. Though the premium filter is not reusable, it may last as much as a year. Before buying such a filter, however, check with your furnace company to make sure this type is compatible with your furnace.

Have the furnace professionally serviced every one or two years, preferably before the heating season begins. Your utility will probably have a service program or can recommend a reliable furnace service company. Servicing usually includes checking the safety controls, the vent duct or chimney venting fan, the fresh-air intake, the heat exchanger, the fan motor, the filter and the supply line.

If your furnace has a built-in humidifier, it should be cleaned at least twice during the heating season, as specified in the manufacturer's manual. Cleaning keeps the humidifier functioning well and reduces the risk of mold growth. Turn off and drain the humidifier for the summer.

- 🔧 Avoid setting the humidity level too high. You can use a hygrometer—a device that measures air humidity—to determine when to turn on the humidifier. (See *The Environment in Your House*, page 17.)

Builder's or Homeowner's Notes

Your furnace has a _____ speed circulating fan.

For More Information

Heating with Oil. Natural Resources Canada, Home Heating and Cooling Series #4.

HEATING: ELECTRIC FURNACE

Troubleshooting

No heat: If there is no activity from the furnace or air flow from the warm air grille within five minutes of setting the thermostat at a higher temperature, take the following steps:

- Ensure that the *Thermostat* control (page 132) is not set to “OFF” or “AIR CONDITIONING.”
- Check the breaker labelled “FURNACE” or “HEATING” at the main electrical panel (*General Information*, page 167). Switch the breaker to “OFF,” then back to “ON.”

Furnace runs for short time, then stops, but no air comes from the warm air grille: If your furnace has a belt-driven fan (i.e., a rubber belt drives the fan motor), remove the lower panel on the furnace to check whether the belt has broken or come off the wheel. If the belt is damaged but you cannot fix it, or if it appears the belt is not the problem, contact a furnace service company.

Noisy furnace: If your furnace has a belt-driven fan, a loose or slipping belt may make a high-pitched squealing noise. See the previous *Troubleshooting* tip for instructions.

No heat from a particular grille: Check that the grille and the duct damper are open (*Forced Air Duct System*, page 130). If that is not the problem, a section of the duct may be blocked or broken. Contact your builder or a heating contractor.

Unbalanced amount of heat to various rooms: Refer to the *Troubleshooting* section of the *Forced Air Duct System*, page 130.

Bad odours from grilles: Something may be rotting in a duct (*Forced Air Duct System*, page 130).

Description

Your furnace, which is powered by the household electrical supply, is both the heat source and distribution centre for your heating system. Because electric heat consumes more power than all other uses, your house has a relatively large electrical service, usually 200 amps. You can interrupt power to the furnace at the main electrical panel (*General Information*, page 167).

Your electric furnace has three key components:

- **Heating elements:** The elements heat air in the furnace.
- **Blower or circulating fan:** A fan circulates heated air through the house’s duct system (*Forced Air Duct System*, page 130), which is why the system is called a “forced air” heating system. Furnaces may be supplied with a three speed fan for ventilation (low speed), heating (medium speed) and air conditioning (high speed).
- **Filter:** The filter screens dust from the air that moves through the furnace. Your furnace has one of the following:
 - a standard disposable filter, mounted in a paper sleeve; or
 - a standard reusable filter, typically made from spun fibreglass or metal, possibly with metal rods embedded for rigidity.

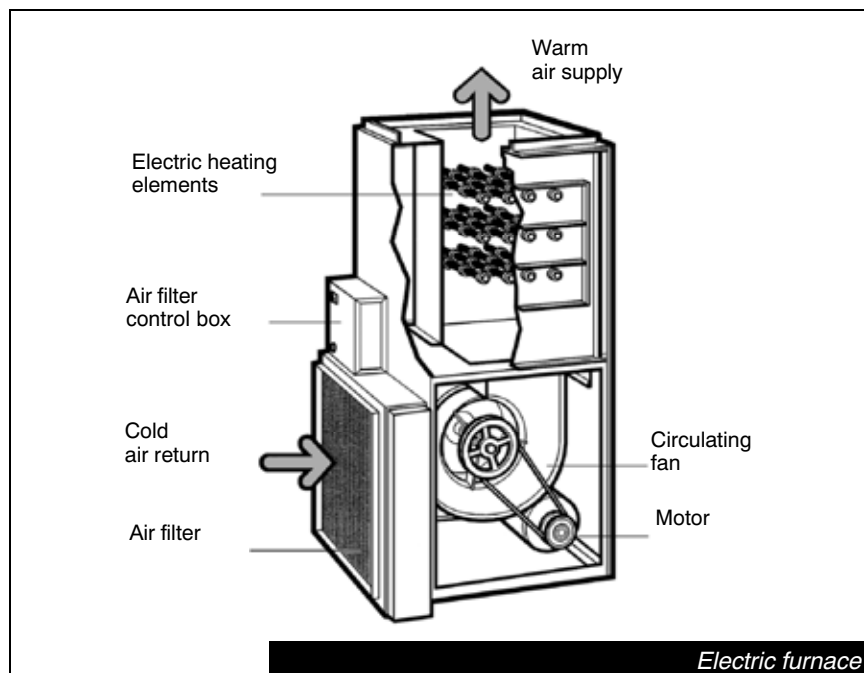

Additional Tips

You can use the furnace fan to help cool your house! On hot days, close the windows and window shades and turn the fan setting to "ON" at the *Thermostat* (page 132) or on the furnace, and the fan will circulate cool basement air through the house. Make sure the heat switch is set to "OFF" or "COOL." On cool, dry nights, leave the furnace fan off and cool the house by opening windows. This will allow the relatively low temperatures of the surrounding earth to cool the basement again. Do not do this in humid weather, however, as it can lead to basement condensation and mold.

 Save energy while away on vacation! Turn your heat down to 10°C (50°F).

- An electrostatic air filter, which electrically charges dust particles passing through the furnace, then removes them by static electric attraction.

Your furnace may have a built-in humidifier which adds moisture to air as it passes through the furnace.

Operation and Maintenance

It takes a few minutes for the fan to come on after you turn up the setting on a *Thermostat* (page 132). Do not set the thermostat higher than the temperature you want: this will not result in faster heating.

A dirty filter reduces the efficiency of your heating system. Check the furnace filter at least every two months during the heating season and change or clean it as necessary. Remove the old filter, which may be found either in a slot on the furnace or behind a removable access panel. If the furnace is fitted with a disposable filter, replace it with a new filter of the same size, available from a hardware store. If the filter is reusable, vacuum the dirty side, using the vacuum's hand attachment; some filters can then be washed in soapy water and rinsed. If you have an electrostatic air filter, consult the manufacturer's instructions on regular cleaning.

-  If you have a standard filter, consider replacing it with a premium (pleated) filter, as this type of filter will do a better job of maintaining indoor air quality. Though the premium filter is not reusable, it may last as much as a year. Before buying such a filter, however, check with your furnace company to make sure this type is compatible with your furnace.

Have the furnace professionally serviced every one or two years, preferably before the heating season begins. Your utility will probably have a service program or can recommend a reliable furnace service company. Servicing usually includes checking the elements, the fan motor and belt, the safety controls and the filter.

If your furnace has a built-in humidifier, it should be cleaned annually, as directed in the manufacturer's manual. Cleaning keeps the humidifier functioning well and reduces risk of mold growth. Turn off and drain the humidifier for the summer.

-  Avoid setting the humidity level too high. You can use a hygrometer — a device that measures air humidity — to determine when to turn on the humidifier. (See *The Environment in Your House*, page 17.)

**Builder's or
Homeowner's Notes**

Your furnace has a _____ speed circulating fan.

For More Information

Heating with Electricity. Natural Resources Canada, Home Heating and Cooling Series #2.

HEATING: PROPANE FURNACE

Troubleshooting

No heat: If there is no sign of activity from the furnace (e.g., vibration or combustion noise, or air flow from the warm air grille) within five minutes of setting the thermostat at a higher temperature, take the following steps:

- Ensure that the *Thermostat* control (page 132) is not set to “OFF” or “AIR CONDITIONING.”
- Check that the emergency on/off switch has not been accidentally turned off.
- At the main electrical panel (*General Information*, page 167), check that the breaker labelled “FURNACE” or “HEATING” is set correctly. Switch the breaker to “OFF,” then back to “ON.”
- If a pilot light ignites the gas in the combustion chamber, check that it is on.
- If there is still no activity, call your fuel supplier or a furnace service company.

Furnace runs for short time, then stops, but no air comes from the warm air grille: If your furnace has a belt-driven fan (i.e., a rubber belt drives the fan motor), remove the lower panel on the furnace to check whether the belt has broken or come off the wheel. If the belt does not appear to be the problem, or if it is damaged but you cannot fix it, contact your gas utility or furnace service company.

 Remember to turn off the power to your furnace at the emergency switch or electrical panel (*General Information*, page 167) before opening the access panel.

Noisy furnace: If your furnace has a belt-driven fan, a loose or slipping belt may make a high-pitched squealing noise. See the *above Troubleshooting* tips for instructions.

Description

Your propane furnace is both the heat source and distribution centre for your heating system. A tanker truck supplies propane to a storage tank, located outside the house. A gauge on the tank indicates the fuel level. Propane is piped to the house through a hose, which may be buried if the tank is located away from the house. The hose has a shut-off, usually located just inside the house or near the connection with the furnace.

Your furnace has four key components:

- **Combustion chamber:** Here the propane burns to create heat. The propane is lit by electric ignition or a pilot light.
- **Heat exchanger:** A series of metal plates or tubes transfer the heat from the combustion chamber to the household air supply.
- **Blower or circulating fan:** The fan circulates heated air through the house’s duct system (*Forced Air Duct System*, page 130), which is why the system is called a “forced air” heating system. Furnaces may be supplied with a three speed fan for ventilation (low speed), heating (medium speed) and air conditioning (high speed).
- **Filter:** The filter screens dust from the air that moves through the furnace. Your furnace has one of the following:
 - a standard disposable filter, mounted in a paper sleeve;
 - a standard reusable filter, typically made from spun fibreglass or metal, possibly with metal rods for rigidity; or
 - an electrostatic air filter, which electrically charges dust particles passing through the furnace, then removes them by static electric attraction.

The duct that provides combustion air to the furnace usually enters the house at the top of the basement wall and hangs down inside the wall. Your furnace is designed so that gases created during combustion never mix with household air. They are vented directly to the outside, either by a fan that blows them through a duct at the side of the house, or through a chimney. A safety device shuts the furnace down if a powered venting system fails. In high efficiency furnaces, which have relatively cool exhaust, the water vapour in the combustion gases condenses, and usually runs into a floor drain or is pumped to a laundry tub.

An emergency on-off switch for the furnace is usually located on the basement ceiling or wall near the stairs. This looks like a light switch but should be labelled “FURNACE.”

Troubleshooting Cont'd.

No heat from a particular grille:

Check that the grille and the duct damper are open (*Forced Air Duct System*, page 130). If that is not the problem, a section of the duct may be blocked or disconnected. Contact your builder or a heating contractor.

Unbalanced amount of heat to various rooms: See the *Troubleshooting* section of the *Forced Air Duct System*, page 130.

Bad odours from the grilles: Something may be rotting in a duct (*Forced Air Duct System*, page 130).

⦿ A fuel smell may indicate a propane leak. Check your other propane appliances first. If they are not the source of the leak, turn the propane off at the shut-off, open the windows and doors and leave the premises. Call your fuel supplier or furnace service company from a neighbour's house. (See *A Safe and Secure Home*, page 26, for information on reducing the risk of gas leaks, and responding to them.)

Headaches, dizziness, sleepiness or nausea: Odourless combustion gases, if they enter the house's air supply, may cause these symptoms. If gas is suspected, open windows, shut off the furnace and call your gas utility or furnace service company without delay. Seek immediate medical attention for any symptoms associated with combustion gases.

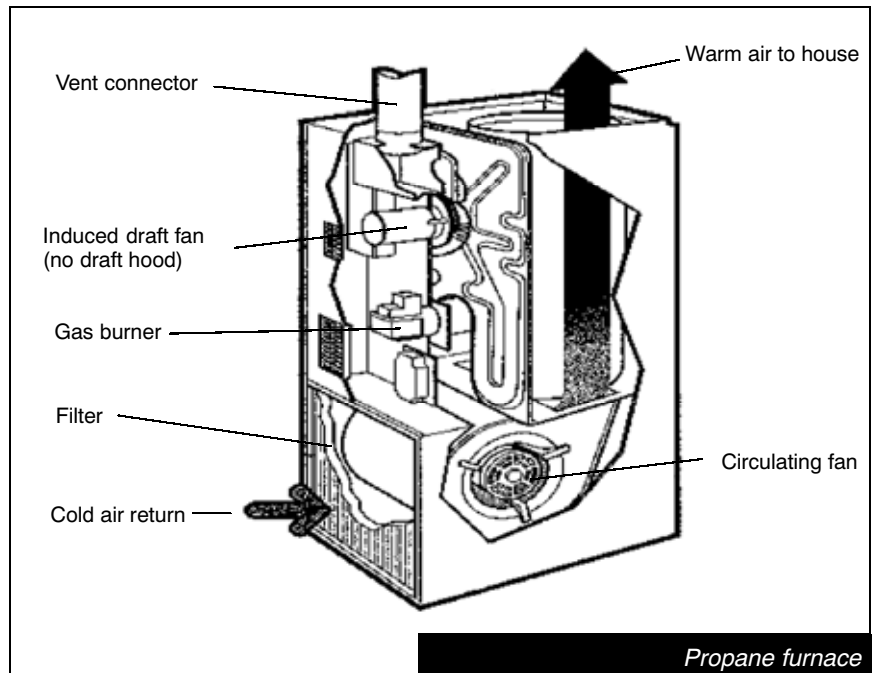

Propane furnace

A built-in humidifier, which adds moisture to air passing through the furnace, may have been added to your heating system.

Operation and Maintenance

It takes a few minutes for the fan to come on after you turn up the setting on a *Thermostat* (page 132). Do not set the thermostat higher than the temperature you want: this will not result in faster heating.

To avoid blocking the flow of air around the furnace and to prevent fires, do not store anything — especially flammable or toxic household chemicals — against or around the furnace. An uncluttered area around the furnace also makes access for maintenance and repair easy.

Check the fuel level periodically during the heating season to ensure that you do not run out.

A dirty filter reduces the efficiency of your heating system. Check the furnace filter at least every two months during the heating season, and change or clean it as necessary. Remove the old filter, which may be found either in a slot on the furnace or behind a removable access panel. If the furnace is fitted with a disposable filter, replace it with a new filter of the same size, available from a hardware store. If the filter is reusable, vacuum the dirty side, using the vacuum's hand attachment; some filters can then be washed in soapy water and rinsed. If you have an electrostatic air filter, consult the manufacturer's instructions on regular cleaning.

Propane Furnace

Additional Tips

If the hose from the tank to the furnace is buried, take care when gardening or digging nearby.

- Install a carbon monoxide (CO) detector close to the furnace, and another in the bedroom area: these will detect combustion gases that are not being properly exhausted and signal the danger at an early stage.

You can use the furnace fan to help cool your house! On hot days, close the windows and window shades and turn the fan setting to "ON" at the *Thermostat* (page 132) or on the furnace, and the fan will circulate cool basement air through the house. Make sure the heat switch is set to "OFF" or "COOL." On cool, dry nights, leave the furnace fan off and cool the house by opening windows. This will allow the relatively low temperatures of the surrounding earth to cool the basement again. Do not do this in humid weather, however, as it can lead to basement condensation and mold.

- Save energy while away on vacation! Turn your heat down to 10°C (50°F).

- Turn off the power to the furnace at the emergency on/off switch or at the electrical panel (*General Information*, page 167) before opening the furnace access panel.
- If you have a standard filter, consider replacing it with a premium (pleated) filter as this type of filter will do a better job of maintaining indoor air quality. Though the premium filter is not reusable, it may last as much as a year. Before buying such a filter, however, check with your furnace company to make sure this type is compatible with your furnace.

Have the furnace professionally serviced every one or two years, preferably before the heating season begins. Your utility will probably have a service program or can recommend a reliable furnace service company. Servicing usually includes checking the safety controls, the vent duct or chimney venting fan, the fresh-air intake, the heat exchanger, the fan motor, the filter and the supply line.

If your furnace has a built-in humidifier, the mechanism should be cleaned annually, as directed in the manufacturer's manual. Cleaning keeps the humidifier functioning well and reduces risk of mold growth. Turn off and drain the humidifier for the summer.

- Avoid setting the humidity level too high. You can use a hygrometer—a device that measures air humidity—to determine when to turn on the humidifier. (See *The Environment in Your House*, page 17.)

Builder's or Homeowner's Notes

Your furnace has a _____ speed circulating fan.

INTEGRATED HEATING AND HOT WATER SYSTEM

Troubleshooting

No heat: If there is no activity within five minutes of setting the thermostat at a higher temperature, take the following steps:

- At the main electrical panel (*General Information*, page 167), check that the breakers labelled “HEATING” and “HOT WATER TANK” are set. Switch the breaker to “OFF,” then back to “ON.”
- If the blower fan is belt-driven (i.e., a rubber belt drives the fan motor), remove the access panel on the air-handling unit to check whether the belt has broken or come off the wheel. If the belt is damaged but you cannot fix it, or if it appears the belt is not the problem, contact your utility or service company.
- Refer to the *Hot Water Tank* (page 146) for additional tips.

No heat from a particular grille:

Check that the grille and the duct damper are open (*Forced Air Duct System*, page 130). If that is not the problem, a section of duct may be blocked or broken. Contact your builder or a heating contractor.

Inadequate heat: If you use a high volume of hot water in a short period of time, the water in the tank may not be hot enough for adequate space heating. If so, try to reschedule your hot water demands (e.g., space out showers and hot water laundry loads).

Unbalanced amount of heat to various rooms: See the *Troubleshooting* section of *Forced Air Duct System* on, page 130.

Noisy air-handling unit: If your unit has a belt-driven blower fan, a loose or slipping belt may make a high-pitched squealing noise. See the first *Troubleshooting* tip for instructions.

Bad odours from the grilles: Something may be rotting in a duct (*Forced Air Duct System*, page 130).

Description

Your system combines heating with a high-efficiency hot water tank. Like any standard hot water tank, this one provides hot water for domestic uses, such as showering, bathing and washing. In addition, a series of heat exchange loops run from the hot water tank into the heat exchange chamber of an air-handling unit (which looks like a furnace cabinet but has no combustion chamber). Here, heat transfers from the hot water to air that flows through the chamber. This integrated system may be more energy-efficient (using less fuel) than a separate furnace.

- See *Hot Water Tank*, page 146, for additional information on this component of your integrated heating system.

Your hot water tank may be heated by **electricity, gas or oil.**

Two important components of your air-handling system are:

- **Circulating (blower) fan:** The fan delivers heated air to the house through a network of ducts, which is why this method of heat delivery is called “forced air” heating (*Forced Air Duct System*, page 130). Furnaces may be supplied with a three speed fan for ventilation (low speed), heating (medium speed) and air conditioning (high speed).
- **Filter:** The filter screens dust from the air that moves through the air-handling unit. Your air-handling unit has one of the following:

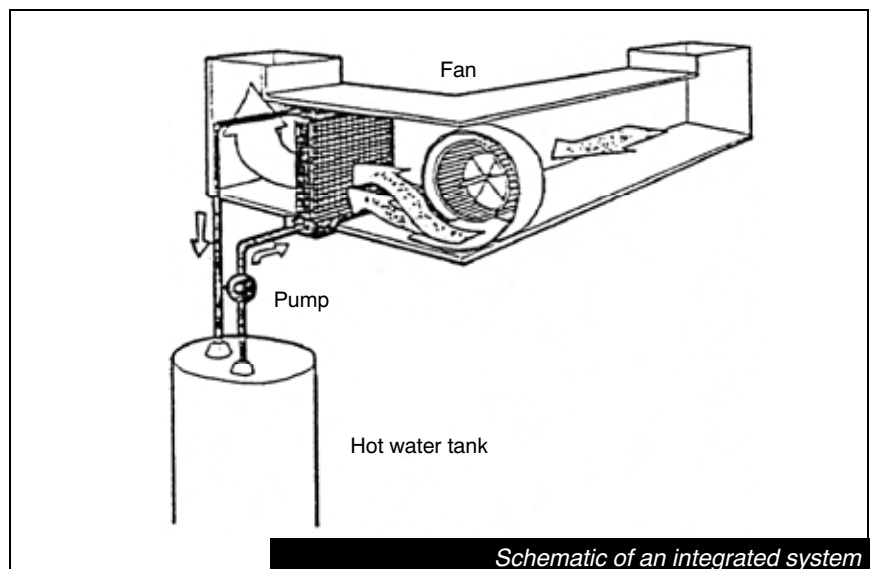

Troubleshooting Cont'd.



If you smell gas, first check to see if any of your gas appliances have been accidentally turned on. If this is not the source of the gas, open the windows and doors to ventilate the house and leave the premises immediately. Do not turn on any electrical lights or appliances or generate any sparks or flames. Call your gas utility from a neighbour's house. (See *A Safe and Secure Home*, page 26, for information on reducing the risk of gas leaks and responding to them.)

Headaches, dizziness, sleepiness or nausea: Odourless combustion gases, if they enter the house's air supply, may cause these symptoms. If gas is suspected, open windows, shut off the furnace and call your utility or furnace service company immediately. Seek immediate medical attention for any symptoms associated with combustion gases.

Additional Tips



Unless your hot water tank is electric, consider installing a carbon monoxide (CO) detector close to the tank. This will detect combustion gases that are not being properly exhausted and signal danger at an early stage.

You can use the furnace fan to help cool your house! On hot days, close the windows and window shades and turn the fan setting to "ON" at the *Thermostat* (page 132) or on the furnace, and the fan will circulate cool basement air through the house.

- a standard disposable filter, mounted in a paper sleeve;
- a standard reusable filter, typically made from spun fibreglass or metal, possibly with metal rods for rigidity; or
- an electrostatic air filter, which electrically charges dust particles passing through the furnace, then removes them by static electric attraction.

Your system may also have a built-in humidifier, which adds moisture to air passing through the air-handling unit.

Operation and Maintenance

It takes a few minutes for the fan to come on after you turn up the setting on a *Thermostat* (page 132). Do not set the thermostat higher than the temperature you want: this will not result in faster heating.

A dirty filter reduces the efficiency of your heating system. Check the furnace filter at least every two months during the heating season, and change or clean it as necessary. Remove the old filter, which may be found either in a slot on the furnace or behind a removable access panel. If the furnace is fitted with a disposable filter, replace it with a new filter of the same size, available from a hardware store. If the filter is reusable, vacuum the dirty side, using the vacuum's hand attachment; some filters can then be washed in soapy water and rinsed. If you have an electrostatic air filter, consult the manufacturer's instructions on regular cleaning.



If you have a standard filter, consider replacing it with a premium (pleated) filter, as this type of filter will do a better job of maintaining indoor air quality. Though the premium filter is not reusable, it may last as much as a year. Before buying such a filter, however, check with your furnace company to make sure this type is compatible with your furnace.

Have your heating system — that is, your hot water tank plus air-handling system — professionally serviced every two years, preferably before the heating season begins. Your fuel supplier can probably arrange for servicing or recommend a reliable service company.



If your system has a built-in humidifier, it should be cleaned annually as directed in the manufacturer's manual. Cleaning keeps the humidifier functioning well and reduces the risk of mold growth.



Avoid setting the humidity level too high. You can use a hygrometer — a device that measures air humidity — to determine when to turn on the humidifier. (See *The Environment in Your House*, page 17.)

**Additional Tips
Cont'd.**

Make sure the heat switch is set to "OFF" or "COOL." On cool, dry nights, leave the furnace fan off and cool the house by opening windows. This will allow the relatively low temperatures of the surrounding earth to cool the basement again. Do not do this in humid weather, however, as it can lead to basement condensation and mold.

  Save energy while away on vacation! Turn your heat down to 10°C (50°F).

**Builder's or
Homeowner's Notes**

Your furnace has a _____ speed circulating fan.

ELECTRIC BASEBOARD HEATING

Additional Tips

With electric baseboard heating, there is a lag time between turning on the unit, and producing the desired heat. Do not set the thermostat higher than the desired temperature: this only wastes energy and causes discomfort.

In many areas electricity is a “high end” and relatively expensive form of energy for heating. Use it wisely. Turn heat down in unused rooms and reduce temperature settings at night, and when the house is unoccupied. At the same time though, keep an eye out for condensation in cooler areas of the house. (See *The Environment in Your House*, page 17, for further information.) Where a house has more than one heat source, rely primarily on the cheaper form.

Description

Electric baseboard heaters in rooms throughout the house provide heat. The temperature is controlled:

- by a dial on each individual heater; or
- at a thermostat on a wall inside each room.

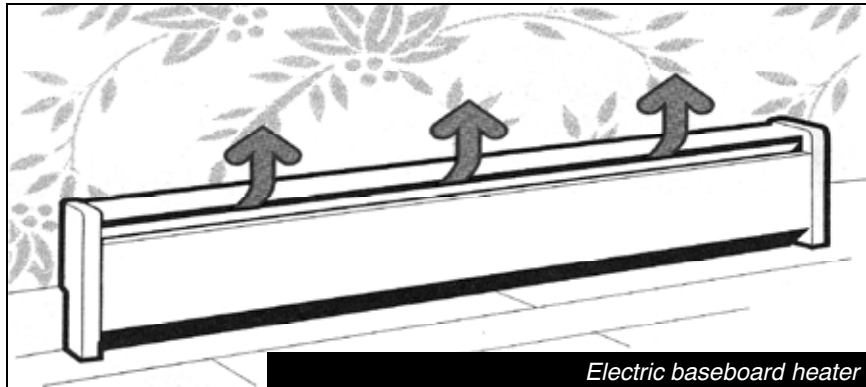

Operation and Maintenance

Baseboard heaters require very little maintenance. To ensure good air flow, use a brush or vacuum to clean dust from the fins once in the fall, and occasionally during the heating season.

To get maximum heat from your baseboards, do not block the heat flow with furniture or window coverings. Baseboard heaters are equipped with a control to prevent overheating; this will shut the heater off if the air flow is restricted.

For More Information

Heating with Electricity. Natural Resources Canada, Home Heating and Cooling Series #2.

WOOD FIREPLACE OR HEATING STOVE

Troubleshooting

Viewing glass is blackened:

Clean off any tar deposits on glass using a specialized cleaner available from fireplace suppliers. These deposits result from incomplete combustion and, if they occur often, you should correct the source of the problem. Make sure that you use dry wood and that you let enough air into the fire. Follow the manufacturer's instructions on adjusting the amount of air circulating through the fire. Also, in setting and stoking the fire, do not place the wood too close to the doors.

Smoke backs into the room:

Smoke backs up when the draft in the chimney is inadequate. Manipulate the air control to increase air flow. If necessary, open the fireplace or stove door and add newspaper to get a fast hot flame. If this does not help, the problem may lie with an imbalance in the ventilation system. For example, if too much household air is being removed by exhaust fans or from the clothes dryer and not enough air is returning through the warm air grilles or from other sources, replacement air may be drawn down through the chimney: this is potentially dangerous. To address the immediate problem of a smoky room, open inside doors to rooms around the fireplace or stove, open a nearby window or one in the basement, turn off exhaust fans or other sources of exhaust and make sure that warm air grilles in the area are not blocked. If the problem persists, stop using the fireplace or stove and contact your builder or a specialist.

One room too hot, the rest of the house too cold: A smaller, cooler fire may be sufficient; adjusting the flow of air to the fire will raise or lower its temperature. If your house

Description

A fireplace set in a “zero-clearance” unit (one that is built into a wall or has framing built around it) lets you enjoy the beauty of a real, visible fire. Until recently, fireplaces provided little heat to the house and, in some cases, actually drew warm air up the chimney and caused a net heat loss. However, your fireplace includes features to improve burning efficiency and to ensure that more of the fire-generated heat is delivered to the house.

A wood stove, which was traditionally used for heating, differs from a fireplace in that it is a free-standing unit set on a non-flammable hearth at a safe distance from the walls. Because wood stoves are exposed on all sides, they transfer heat very effectively to the surrounding space. Moreover, the new generation of wood stoves is both cleaner burning and more efficient than previous generations.

The chimney is double-walled, insulated metal pipe that runs from the level of the fire to the roof. Stoves have an exposed section of flue pipe connecting the firebox and the chimney. On the outside of the house, the metal chimney may be left bare or it may be clad in an *Exterior Finish* (page 57), often the same as that used on the house. While the fire is burning, the chimney produces a draft that exhausts smoke upward and to the outside. Some fireplaces are equipped with ducts to distribute the heat to other parts of the house.

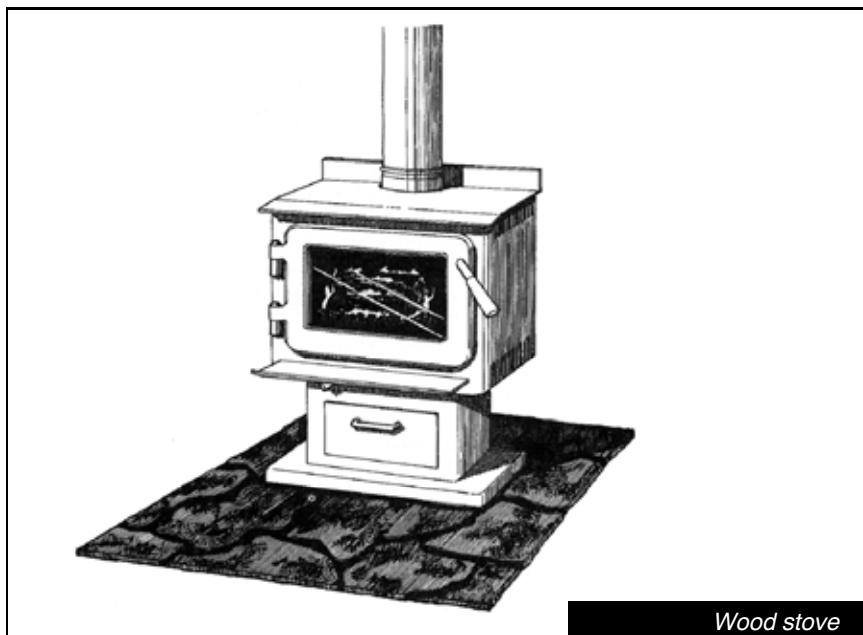

Wood stove

Wood Fireplace or Heating Stove

Troubleshooting Cont'd.

has a forced air system, set the house heating and ventilation system to "FAN" only, or turn it to low speed between heating cycles: this will help circulate heat from the fire around the house. It might also be that the fireplace is radiating heat too directly to the thermostat. If so, try to screen the thermostat from the fireplace or consider moving it.

Operation and Maintenance

Although efficient fireplaces and wood stoves have relatively low air requirements, there must be a supply of outside air to support the fire, and combustion gases must be released to the outside. Consult the manufacturer's instructions on using the flue damper and other mechanisms to control the flow of fresh air to the fire. In general, plenty of air is needed to start and establish a good fire and draft, but, once the fire is going, the amount of air can be reduced.

Many modern fireplaces are designed with grilles at the bottom and top to allow room air to circulate around the firebox; thus, heat is picked up and delivered back to the room without risk of the air mixing with combustion gases. Fireplaces designed in this way may have separate controls to allow for different levels of heat exchange: consult the manufacturer's instructions.

To set a fire, put six to ten sheets of separately crumpled newspaper on the grate or at the bottom of the firebox. Place ten to fifteen pieces of dry, finely split kindling over the newspaper, thinnest pieces first and with the next pieces placed at right angles across these so that air and flames can pass through the stacked wood. Finally, place one or two small pieces of firewood on top of the kindling. Once the flames have partly consumed the kindling, lay more firewood across the burning wood. Wood loaded compactly with logs parallel to each other will burn

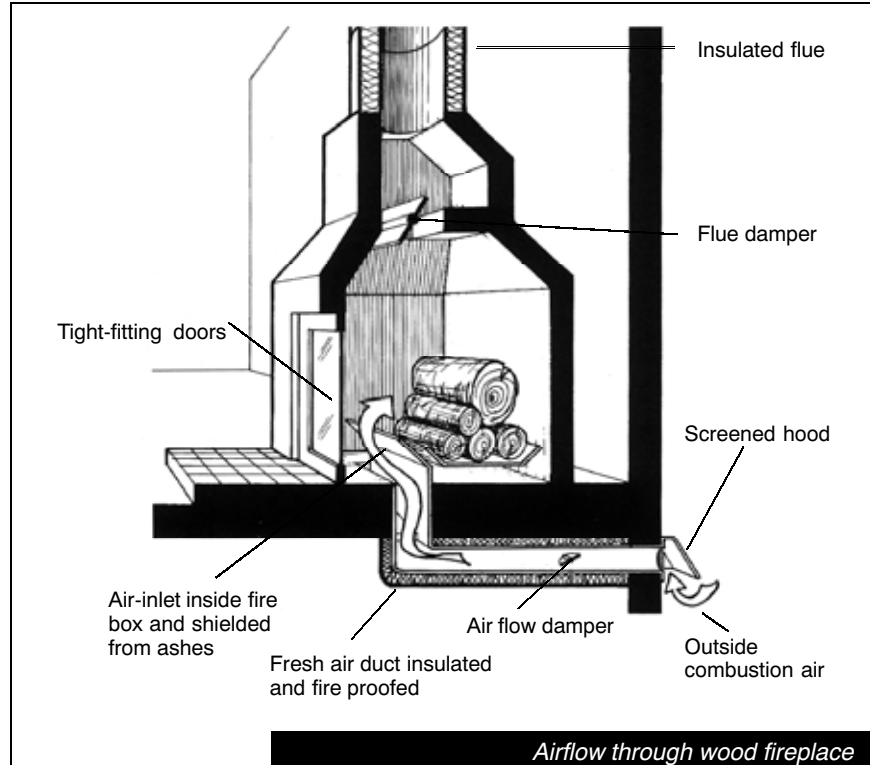
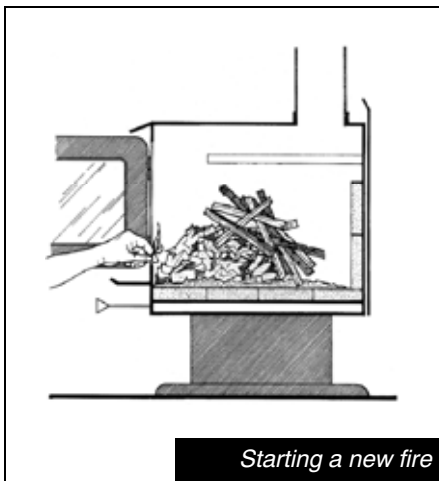

Additional Tips



A carbon monoxide (CO) detector is recommended with a wood-burning appliance.

For easy and safe fires, use dry firewood and kindling. Protect firewood from rain and snow and store it in a criss-cross pattern to let air circulate. Softwoods, such as cedar or pine, make good kindling. Many species of trees produce a good fire: however, hardwoods such as birch burn especially well and are easy to split into good-sized logs.

Do not store more than a few pieces of firewood inside the house. Wet firewood contains a surprising amount of water, and this can contribute to excessive humidity in the house. The moisture in firewood can also foster mold growth, which can, in turn, cause health problems for occupants.

Use a thermometer, available from a wood stove supplier, to measure the temperature of the fire in a wood stove: this will help you decide when to adjust the air flow.



Keep flammable materials away from the fireplace and put nothing directly under, beside or behind a wood stove.

For more efficient heating, keep the doors of the fireplace or stove closed during operation. If the doors are left open, place a properly fitted fire screen over the opening.

To get as much radiant heat as possible in the house, keep the glass doors of the fireplace clean. A fireplace dealer can recommend a good cleaner.

If you have a wood stove with a catalytic combustion, brush it clean or vacuum it two or three times during the heating season. Clean it more thoroughly or replace it every one to three years, depending on how much the stove is used. Read the manufacturer's instructions.

Creosote, an oily black substance released during incomplete combustion of burning wood, can build up inside the chimney and create a fire hazard. While little, if any, creosote is produced in a well run modern fireplace or stove, it is still advisable that the chimney be professionally cleaned once a year, preferably before the heating season. You can clean the chimney yourself with a brush-and-rod kit from a fireplace supplier, but be prepared for a messy job.

Inspect your fireplace at least once a year, replacing door gaskets and other seals as required. If you notice any other problems, hire a qualified chimney sweep to do a thorough inspection.

Builder's or Homeowner's Notes

Specifics on key features of fireplace or stove

Information on ducting of fireplace to adjacent rooms or basement, as relevant

For More Information

A Guide to Residential Wood Heating. Natural Resources Canada and CMHC, Home Heating and Cooling Series #35.

All About Wood Fireplaces. Natural Resources Canada, Home Heating and Cooling Series #6.

GAS FIREPLACE OR HEATING STOVE

Troubleshooting

One room too hot, the rest of the house too cold: A lower heat setting on the stove or fireplace may be sufficient. If your house has a forced air system, set the house heating and ventilation system to "FAN" only, or turn it to low speed between heating cycles: this will help circulate heat from the fire around the house. It might also be that the fireplace is radiating heat directly toward the *Thermostat* (page 132). If so, try screening the thermostat from the heat or consider moving it.

Additional Tips

- 🔥 A carbon monoxide (CO) detector is recommended with a gas appliance.
- 🕒 If your stove is ignited by a pilot light, turn the pilot off during the summer months.

Description

By spreading a gas flame through a stack of artificial logs, gas fireplaces and stoves give the appearance of a wood fire. Thus, they let you enjoy the beauty of a real, visible fire, at the same time providing heat with all the convenience and clean operation of a gas appliance.

A gas fireplace is either built into a wall or framed and finished, while a stove is free-standing. Both are now designed to maximize the circulation of heat into the room. Some gas stoves and fireplaces even have ducts to distribute heat to other parts of the house.

Combustion gases from the fire are exhausted through a chimney to the roof, or through a duct to an outside wall. A supply of outside air for combustion is typically provided directly to the unit.

Operation and Maintenance

The gas fireplace or stove is turned on either by a pilot light or by electric ignition, with a switch at the unit or on a nearby wall.

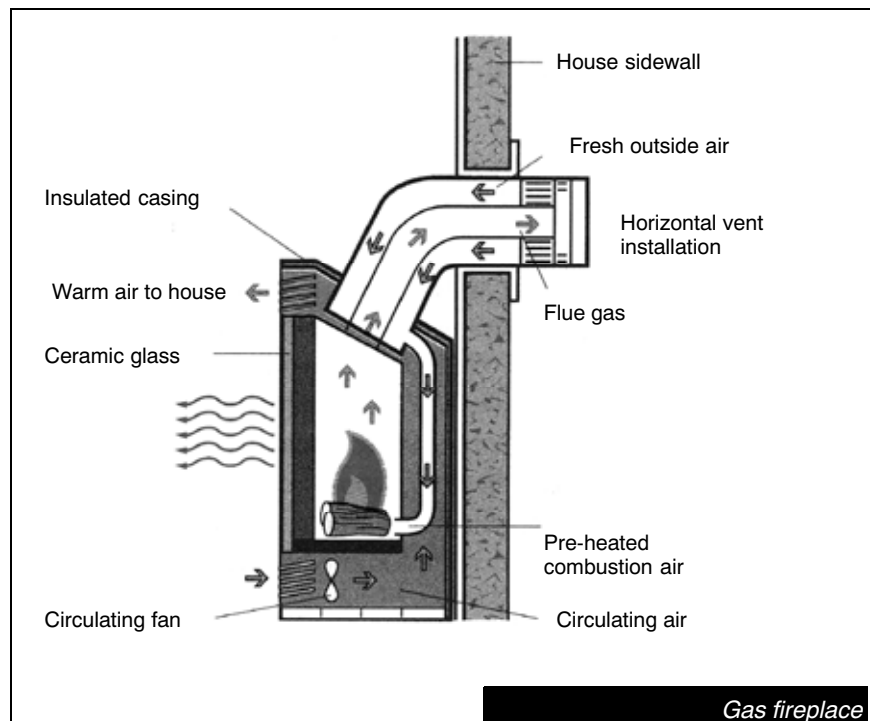

Part Two — Heating, Ventilation and Air Conditioning

A gas fireplace or stove requires little maintenance. Have it checked at the same time as the heating and ventilation system is serviced. If your fireplace or stove is ducted to an outside wall, keep the duct opening clear; especially in winter, do not let snow pile up.

Builder's or Homeowner's Notes

Specifics on key features of fireplace or stove

Information on ducting of fireplace to adjacent rooms or basement,
as relevant

For More Information

Heating with Gas. Natural Resources Canada, Home Heating and Cooling Series #3.

HEATING AND COOLING SYSTEM: HEAT PUMP

Troubleshooting

No air comes from the warm air grilles: If the system has a belt-driven blower fan (i.e., a rubber belt drives the fan motor), check whether the belt has broken or come off the wheel. If the belt is damaged and you cannot fix it, or if it appears the belt is not the problem, contact your gas utility or furnace company.

 Remember to turn off the power to the air-handling unit before opening the access panel to the fan.

Noisy furnace: If your furnace has a belt-driven fan, a loose or slipping fan belt may make a high-pitched squealing noise. See the previous troubleshooting tip for instructions.

No heat from a particular grille: Check that the grille and the duct damper are open (*Forced Air Duct System*, page 130). If that is not the problem, a section of duct may be blocked or disconnected. Contact your builder or a heating contractor.

Unbalanced amount of heat to various rooms: See the *Troubleshooting* section of *Forced Air Duct System* in page 130.

Bad odours from the grilles: Something may be rotting in a duct (*Forced Air Duct System*, page 130).

Additional Tips

As the heat pump extracts heat from outside air in winter, you should maximize exposure to sunlight in order to heat up the air around the outside unit (compressor and outside coil). Try to landscape some kind of windbreak for the unit, but without shading it from winter sun.

Description

A heat pump is a central heating and cooling device that operates much like a refrigerator or air conditioner in that it extracts heat from one place and transfers it to another. Since the direction of the transfer can be reversed, the heat pump can be used both to heat the house in winter and to cool it in summer.

Your heating system may consist of:

- **A heat pump and furnace:** The system delivers warm air from both sources to the air-handling unit in the furnace cabinet.
- **A heat pump and some supplementary electric resistance heaters:** Warm air from both sources is delivered to an air-handling unit, which contains a blower fan and filter, then into the *Forced Air Duct System* (page 130).

Most heat pumps are “air source,” so called because, in winter, the pump draws heat from the outside air. The heat pump consists of two heat exchanger coils, one inside the house and the other outside, a liquid called a refrigerant, an expansion device, a compressor and a reversing valve. On its way to the evaporator coil (the evaporator), the liquid refrigerant passes through the expansion device, where pressure is

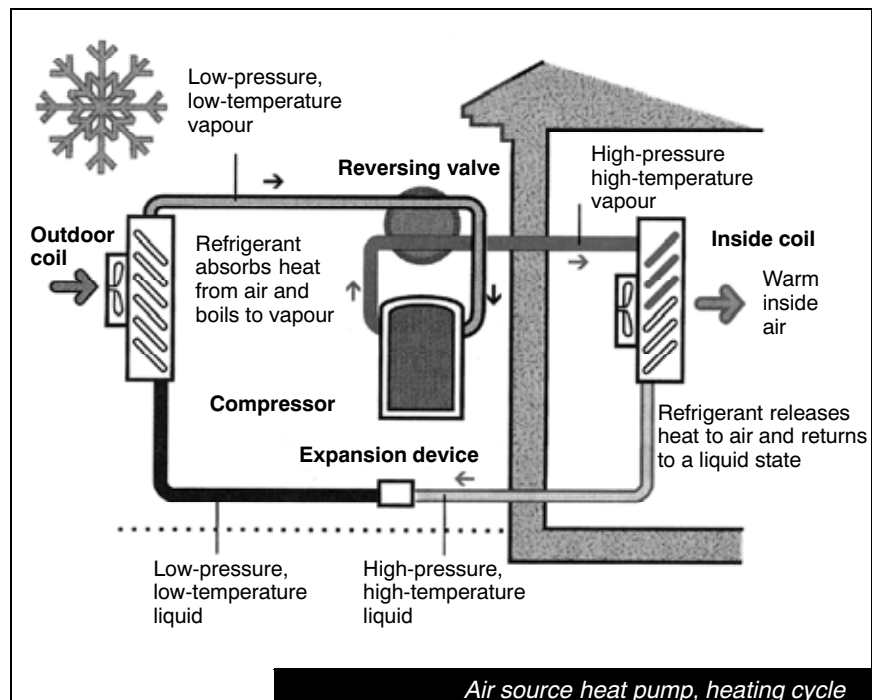

Part Two — Heating, Ventilation and Air Conditioning

released. Arriving at the coil as a low-pressure liquid/gas mixture, the refrigerant absorbs heat from its surroundings, becoming a low-temperature gas. On its way back to the condensing coil (condenser), compression of the refrigerant causes it to heat up. The refrigerant gives up its heat at the coil and condenses back to a liquid. The reversing valve controls the direction of flow of the refrigerant.

In winter, moisture in the outside air can build up as ice on the coil, thus reducing the efficiency of the system. Therefore, the heat pump has a defrost mode that reverses the system for short periods of time, sending inside heat to the outside coils to remove ice build-up.

Operation and Maintenance

It takes a few minutes for the fan to come on after you turn up the setting on a *Thermostat* (page 132). Do not set the thermostat higher than the temperature you want: this will not result in faster heating.

Remember that air source heat pumps become less effective in very cold weather: in such conditions, you may depend more heavily on your supplementary heating system.

A dirty filter reduces the efficiency of your heating system. Check the furnace filter at least every two months during the heating season, and change or clean it as necessary. Remove the old filter, which may be found either in a slot on the furnace or behind a removable access panel. If the furnace is fitted with a disposable filter, replace it with a new filter of the same size, available from a hardware store. If the filter is reusable, vacuum the dirty side, using the vacuum's hand attachment; some filters can then be washed in soapy water and rinsed. If you have an electrostatic air filter, consult the manufacturer's instructions on regular cleaning.



If you have a standard filter, consider replacing it with a premium (pleated) filter as this type of filter will do a better job of maintaining indoor air quality. Though the premium filter is not reusable, it may last as much as a year. Before buying such a filter, however, check with your furnace company to make sure this type is compatible with your furnace.

Keeping the coils clean maintains good heat exchange capacity and prolongs the life of system parts. Periodically vacuum or brush the outside coil, then carefully wash them, using a garden hose. Do the same with the inside coil, if you can reach it by opening the panel at the air-handling unit; if this coil is inaccessible, have it professionally cleaned during servicing.

Have the heat pump professionally serviced once a year, preferably at some time between the end of the cooling season and the beginning of the heating season. Servicing includes: cleaning the fan, lubricating the

Heat Pump

motor, checking the fan speed, checking that fan belts are intact and tight, and verifying coolant levels.

Builder's or Homeowner's Notes

For More Information

Heating and Cooling with a Heat Pump. Natural Resources Canada,
Home Heating and Cooling Series #1.

COOLING SYSTEM: CENTRAL AIR CONDITIONING

Troubleshooting

Not enough cool air: The volume of air flow may be low. Check that the furnace filter is clean and that all ducts and grilles are open (*Forced Air Duct System*, page 130). Ice build-up on the inside coil can also reduce the system's efficiency. To melt the ice from the coil, empty the drip tray, then turn the *Thermostat* (page 132) to "OFF." The ice will melt, filling the drip tray. Empty the tray, and re-set the thermostat for cooling. If this does not solve the problem, contact a licenced air conditioning technician who will verify the refrigerant level and re-fill if necessary.

Water leaking from the unit: Pour water into the drip tray to verify that the line to the drain is open. It is important that the tray drain properly. If you cannot solve the problem, contact a licenced air conditioning technician.

Unbalanced amount of cool air to various parts of the house: Modifications can be made to ensure balanced distribution of cool air. See the *Troubleshooting* section of the *Forced Air Duct System* on page 130.

Water leaking along the refrigerant line between the air-handling unit and the outside unit: Condensation may result from gaps in the refrigerant line insulation. Repair with pipe insulation, which is available at hardware stores.

Description

Your central air conditioning system removes heat from air that circulates through the house via the same *Forced Air Duct System* (page 130) as that used to heat the house in winter. Usually, the same *Thermostat* (page 132) is used to set the temperature in both summer and winter.

The inside coil of the air conditioning system is in the furnace's air-handling unit, which is usually located at the top of the furnace. A refrigerant (coolant) circulates through the coil, and absorbs heat from the air that is passing through the unit; the air-handling unit then delivers cooled air to your house.

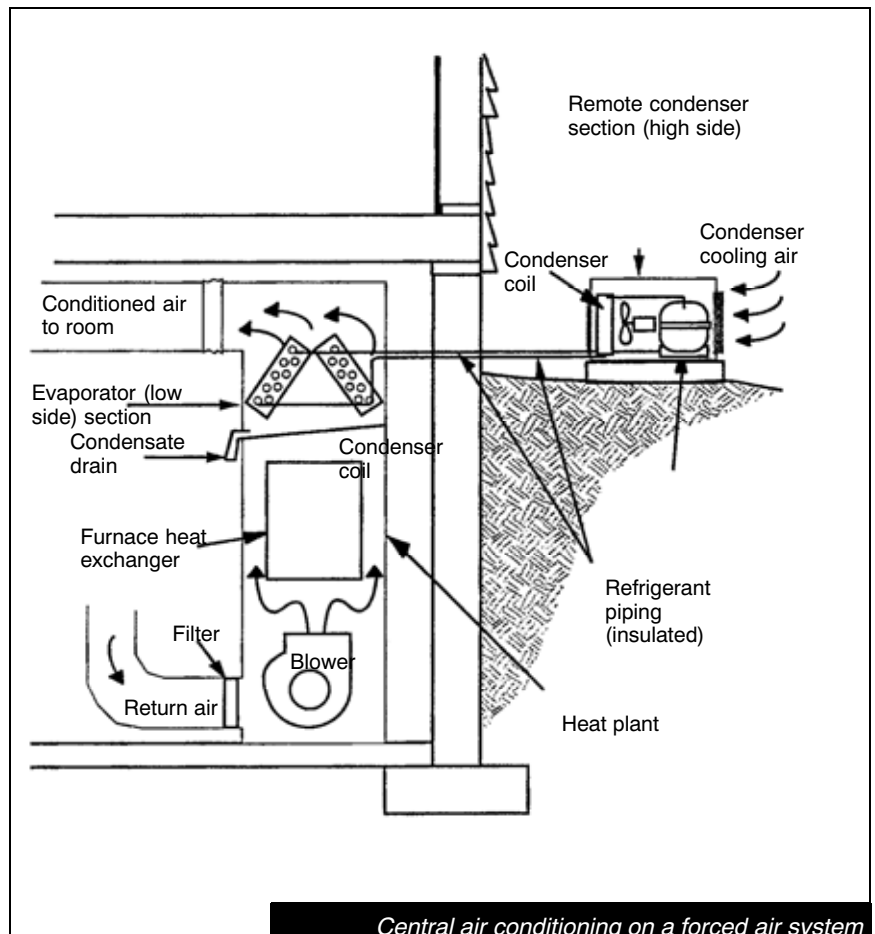

Additional Tips

The outside coil will shed heat more effectively if it is located in a shaded and breezy area. Landscaping can provide shade; however, do not cover the condenser. Allow air movement around the unit.

 Central air conditioning uses a lot of energy. Use it wisely. Keep windows and blinds closed during the day. Avoid using stoves and other appliances that add heat to the house. On cool, dry nights, turn the air conditioner off and open windows instead. Control humidity and reduce the need for air conditioning by using bathroom and kitchen *Exhaust Fans* (page 134) when showering or cooking. See *Landscaping and Vegetation* (page 43) for tips on using landscaping that will keep your home cool.

 Clean up any spills from the drip tray immediately, to prevent mold from forming.

The absorbed heat transforms the refrigerant from liquid to gas, which is then pumped from the inside coil through an insulated hose to an outside unit (usually a square or round metal box with a fan situated at the side or back of the house.) A compressor in the outside unit compresses the gas back to a liquid, thereby releasing heat. This heat is discharged — with the help of a fan — through an outdoor coil (condenser) to the outside air. The liquid refrigerant then returns to the inside coil, where once again it is available to remove heat from the house air. As the air cools at the inside coil, moisture condenses on the coil, collects in a pan at the bottom of the coil, and drains off.

Operation and Maintenance

Resist the temptation to set the thermostat lower than the desired temperature: this will not result in faster cooling, but it will waste energy and possibly over-tax the air conditioner. (See *Additional Tips* for other energy-saving advice.)

Do not cover the outside air conditioning unit or let anything — including landscaping or other objects — interfere with the flow of air around it.

Periodically vacuum or brush the outdoor coil, then carefully wash it. Do the same with the inside coil, if you can reach it by opening the furnace panel at the air-handling unit; if the coil is not accessible, have it professionally cleaned during servicing. Dirty coils reduce the efficiency of the system, and dirty indoor coils encourage the growth of unhealthy molds.

Have the air conditioner professionally cleaned and serviced every year or two, preferably before the cooling season. Servicing should include checking — and, if necessary, adjusting — the refrigerant levels, pump, fan and controls.

 The refrigerant in air conditioners is HCFC-22, which is not as damaging to the ozone layer as CFCs, but it does cause some ozone depletion. Therefore, only a licenced tradesman, one who will comply with government regulations for handling HCFCs, should service these units. At the end of the cooling season, turn the air conditioner off at the electrical panel (*General Information*, page 167). To minimize possible damage to the compressor, reset the breaker to the “ON” position a few days before using the air conditioner again.

**Builder's or
Homeowner's Notes**

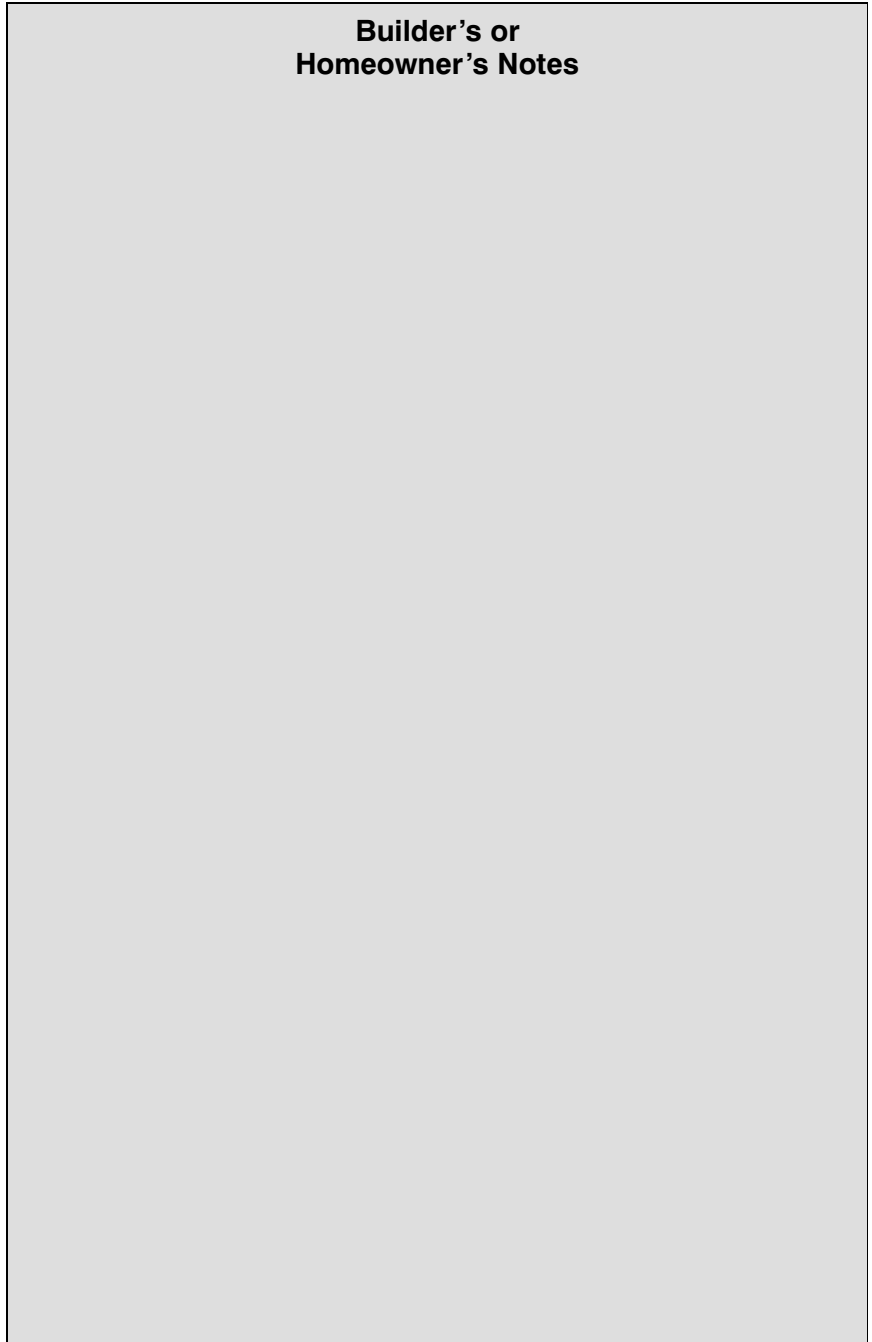

For More Information

Air Conditioning Your Home. Natural Resources Canada, Home Heating and Cooling Series #7.

DISTRIBUTION SYSTEM: FORCED AIR DUCT SYSTEM

Troubleshooting

Bad odours from the grilles: A fuel-like odour can signal a safety or health problem, (*Heating Systems*, page 101). An odour of decay may mean that something is rotting in a duct. If the source of the problem is not visible within arm's reach of the grille, have the ducts professionally inspected.

Unbalanced amount of heat to various rooms: If some rooms are hotter or colder than you would like, try adjusting the grilles (see *Operation and Maintenance*). If this is not effective, try adjusting the duct dampers as follows:

- For dampers located behind the grille, remove the grille and reach into the duct. You should feel a round metal disk that can be turned by hand to increase or decrease the air flow.
- Dampers located on exposed ducts along the basement ceiling are fully open when the handle points towards the duct and are fully closed when the handle points across the duct. Adjust these dampers gradually. Start by ensuring that the dampers for ducts that serve cool rooms are open. If this is not sufficient to warm the cool rooms, slightly close the damper to the warmest room. This adjustment will redirect heat from the warmest part of the house: try it out for a day before adjusting other dampers. Make sure that not too many ducts are either partially or fully closed, as this will make the whole system inefficient.

🔧 If your ducts are not labelled to show what rooms they serve, see *Additional Tips* for guidance on figuring out the connections.

Description

From the air-handling unit of the furnace, the blower fan blows heated air into a duct system that delivers the heat to the whole house. In an unfinished basement, hot air ducts can be seen running along the ceiling. These ducts deliver warm air to rooms in the house through one or more “grilles” (louvred or perforated covers, also called “registers”), usually located in the floor below windows. If you have *Central Air Conditioning* or a *Heat Recovery Ventilator* the same duct system delivers cool or ventilation air to your house.

In addition to hot air ducts, another set of ducts returns air from the house to the furnace, with intake grilles located on an interior wall in each room. Inside finished walls and floors, there is often a system of designated channels that are used as return air ducts: such “ducts” may be simply the enclosed space between adjacent wall studs or floor joists. In an unfinished basement, where there is no drywall to enclose the framing, a section of return air duct running toward the furnace is sometimes created simply by covering the space between two ceiling joists with sheet metal.

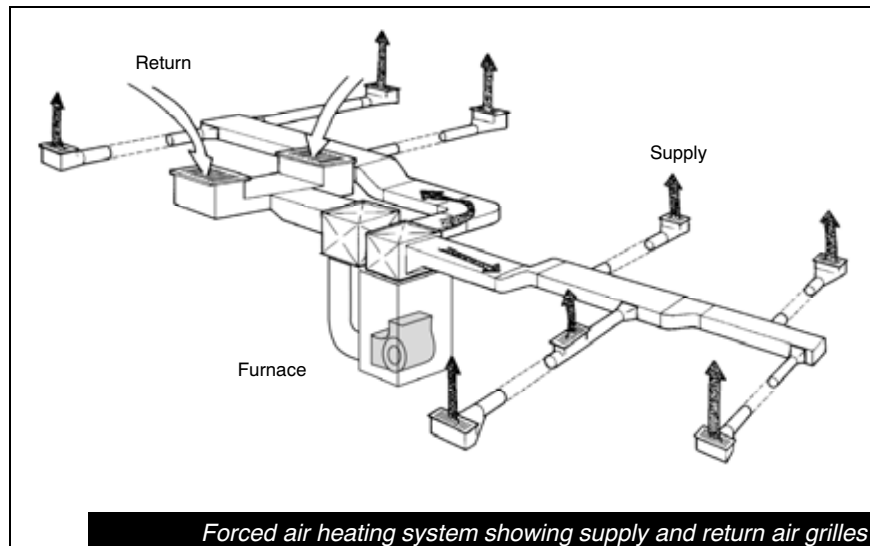

If you do not have a forced air heating system, you still have a *Heat Recovery Ventilator* with its own system of ducts to deliver fresh air and remove stale air. The basic features and maintenance requirements of this ductwork are similar to those described here.

Troubleshooting Cont'd.

- ⚙️ If the joints in the exposed ducts in your basement are unsealed and are leaking air, seal them with a low-odour water-based duct sealant. Duct tape can also be used, but is not as long lasting. Sealing the joints will reduce the amount of heat lost on its way to the house. Before sealing, tighten the screws holding the ducts together at the joint.

Additional Tips

If ducts with basement dampers are not labelled to show what rooms they serve, you can figure out the connections — labelling them as you go — as follows:

- Determine the part of the house the duct runs to by checking where it rises through the basement ceiling.
- Tap the duct at the damper with a metal object while someone else goes to the part of the house served by the duct, and listens at each hot air grille in turn.
- To confirm your findings, close the damper while the fan is running and have the other person check that there is little or no air flow at the identified grille.

To test the balance between air being delivered through the hot air duct and air being removed through the return air duct, try the following technique. Twist a wire coat hanger into a rectangular shape and tape the open end of a regular-sized (66 cm x 91 cm or 26 in. x 36 in.) plastic garbage bag around the wire. Gently deflate the bag and place its mouth over the warm air grille. Time how long it takes the bag to fill with air. Now place the inflated bag over the return air grille and time how long it takes to deflate. The two times should be roughly equal.

Operation and Maintenance

Do not block grilles with furniture or clothing. Grilles can usually be adjusted by hand to control the amount of air delivered to the room. If a room is too cool or too warm, try opening or closing the grille.

Dampers built into each hot air duct allow adjustments to the quantity of warm (or, in the summer, cool) air delivered to different parts of the house. Use the dampers to make long-term changes — for example, if the amount of cool air needed in summer differs from the amount of warm air needed in winter. The dampers are located in one of two places: inside the duct, just behind the grille in each room, or along the exposed section of duct in the basement. See *Troubleshooting* for guidance on using these dampers.

- ♥ Occasionally remove both the warm air and return air grilles, and vacuum as much of the ducts as you can reach. This will remove most of the dust and dirt that gets into the duct system. If your house is especially dusty, or if members of your household are sensitive to dust and other allergens, consider having the ducts professionally cleaned every five years or so.

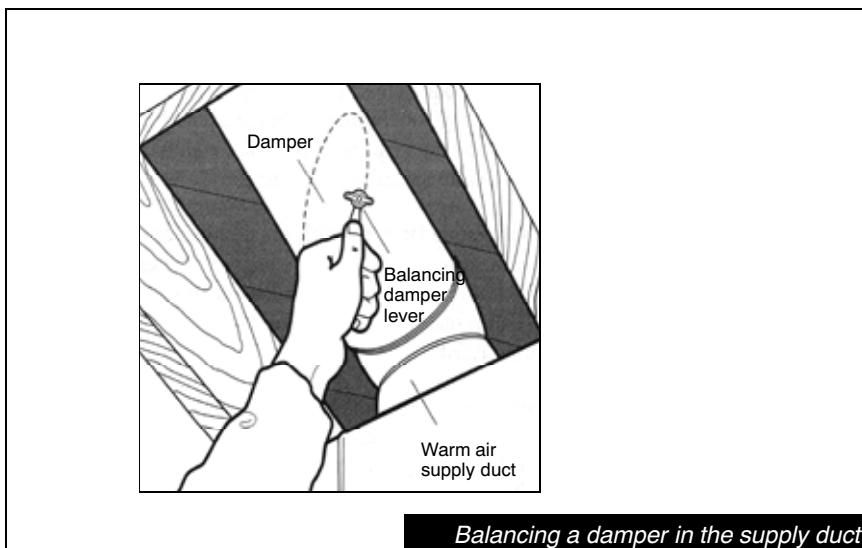

Balancing a damper in the supply duct

THERMOSTAT

Troubleshooting

A fireplace or heating stove makes one room too hot, the rest of the house too cold: If the thermostat is located in the same area of the house as the fireplace or heating stove, it may be subject to locally high temperatures. This means that the thermostat will not trigger, even though other areas of the house cool. (See *Wood Fireplace or Heating Stove*, page 119. *Gas Fireplace or Heating Stove*, page 122.)

Lost program on a setback thermostat: A battery back-up in the thermostat maintains the set program in the event of power failure. If the program is lost, check the batteries.

Description

The thermostat is located on a wall surface, and it should be positioned to protect it from contact with heat sources such as direct sunlight, or hot air ducts and hot water pipes behind the wall.

Your house may:

- have one thermostat, centrally located, which controls heat for the whole house.
- be subdivided into two or more heating/cooling zones; a separate thermostat controls each zone.
- have individual thermostats in each room, or on each heater, controlling the heat from electric baseboard heaters.

The thermostat lets you control the heating in your house so as to regulate temperatures. If you have central air conditioning, the thermostat lets you control cooling as well. At a minimum, your thermostat:

- shows the existing household temperature;
- shows the desired temperature that you have chosen (the set temperature);
- lets you adjust the set temperature; and
- if you have a forced air system, allows you to control the blower fan (*Heating Systems*, page 101.) In some cases, the fan switch is located on the furnace itself.

Your thermostat may be programmable. This type of thermostat — sometimes referred to as a “setback” thermostat — lets you establish a program of different set temperatures throughout the day in accordance with changing needs for heating or cooling.

Some thermostats have additional features. See the manufacturer’s manual for information.

Operation

Do not set the thermostat higher for heating or lower for cooling than the temperature you want. For most types of heating systems, the desired temperature will not be reached any sooner, and energy may be wasted.

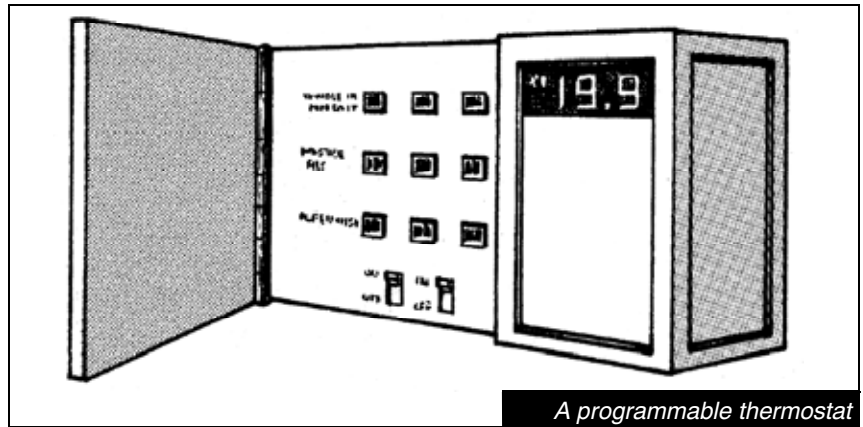

A programmable thermostat

Keep sources of heat or cooling (e.g., a portable heater, floor lamp, television or fan) away from the thermostat, as these appliances will influence the thermostat's reading of the house temperature.

On some forced air systems, you can set the fan to "ON" at the thermostat (or at the furnace), so that it operates even when the heating or cooling sources are off. Some systems have an automatic two-speed fan that operates continuously at low speed when the furnace is not heating and moves to higher speed when the heat comes on. Ongoing circulation tends to distribute air more evenly for greater comfort. However, you may find that the fan is too noisy to operate constantly or that it makes some rooms drafty at some times of day.

- Ⓢ Ⓣ If you have a setback thermostat, consult the manual for instructions on how to program it. Setback thermostats can be programmed to lower the house temperature automatically at night and during school or working hours, when no one is home; similarly, they can be programmed to raise the temperature just before household members rise in the morning and return home in the evening. As a general rule, every 1°C reduction in temperature, either overnight or during the working day, reduces your heating bill by two per cent. Remember, however, that setting the temperature too low can cause condensation, which can in turn encourage mold growth (see *The Environment in Your House* (page 17) including *Ensuring Energy-efficient Operation* (page 23.)

**Builder's or
Homeowner's Notes**

VENTILATION SYSTEM: EXHAUST FANS

Troubleshooting

Noisy fan: Install a high-quality fan and ensure proper vibration isolation.

Fan does not appear to be clearing moisture from the room:

Remember that in most cases, the fan will not immediately clear the moisture from the room. To test whether the fan is working, turn it on and see if it draws up a puff of smoke or flutters a piece of tissue paper held against it. (You can test the exhaust duct of a central ventilation system in the same way.) If the fan is drawing air, the problem is either that the fan is not powerful enough, or the outside damper or duct cover has seized shut. While the fan is operating, check for steam or air movement where the air exhausts to outside the house. If no air seems to be coming out, operate the fan for several minutes to thaw any ice that might be preventing the damper or cover from working properly; or, if you can easily reach the duct opening, try freeing the damper or cover by hand. If these measures do not work, discharge the humidity by opening a nearby window for a minute and call a heating and ventilation contractor.

Water drips out of the fan: The moisture in the air is condensing around or inside the duct. First, check that the fan housing is well sealed to the ceiling. If necessary, use caulking or contractor tape to reinforce the seal. If the seal is sound, there may be insufficient insulation or slope on the duct. Contact your builder or a heating and ventilation specialist.

Leaks, water stains or other signs of condensation in the walls or attic: If the duct leading from the exhaust fan to the outside is disconnected anywhere along its

Description

Humidity and odours are most likely to occur in the kitchen or bathrooms. Therefore, in all new homes, regulations require some means of directly exhausting air from these rooms. This requirement may be met by a central (principal) exhaust system, a Heat Recovery Ventilator system, exhaust fans in the kitchen and bathrooms, or by some combination of these.

A central exhaust system is composed of exhaust ducts leading from the kitchen, bathrooms and possibly from other areas of the house. A single exhaust fan, usually with a centrally located switch, draws air from these rooms and into the ducts. When the fan is switched on, the blower fan (*Heating Systems*, page 101) is also activated, and it circulates air through the house via the *Forced Air Duct System* (page 130).

Ventilation requirements may be met by the central (principal) exhaust system.

Exhaust fans may also remove air to the outside through their own dedicated duct. These fans are usually located in the kitchen or one or more bathrooms.

The ventilation requirements may be met by a combination of a *Heat Recovery Ventilator* and one or more supplementary exhaust fans in the kitchen or one or more bathrooms.

The kitchen fan is usually located inside the stove “hood” above the stove, and it is often called the “stove hood fan” or “range hood fan.” Less commonly, the stove may have its own built-in fan, which draws air

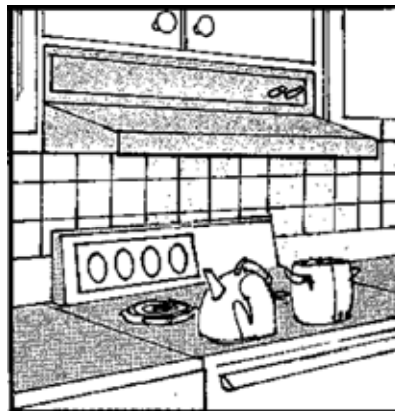

Stove hood fan

**Troubleshooting
Cont'd.**

length, moist exhaust air will dump into the walls or attic at the breakpoint. If there is a break in the duct, you will see little or no steam or air movement at the exterior metal cap. In this case, call your builder or a heating and ventilation contractor to repair the duct. However, remember that there are many possible sources of condensation and leakage in the walls and attic of a house. (See the *Guide to Common Problems*, “Condensation” and “Leaks,” on page 8.)

The fan does not turn on: Check that the breaker at the electrical panel is set (*General Information*, page 167). If the breaker is set, it may be that the fan has burned out. Call an electrician for servicing or replacement.

down. The switch for the stove hood fan is usually located on the front edge of the hood. The fan draws air from the stove into a duct leading directly to the outside. This fan will remove odours, heat and excess moisture created during cooking or boiling water. A metal mesh screen on the underside of the hood protects the fan from grease.

The fan in your stove hood may be recirculating, rather than venting to outside. This fan draws air up from the stove and passes it through a charcoal filter that is meant to remove smoke and odours. However, as the filtered air recirculates back into the kitchen, the fan does not remove heat or excess humidity.

The bathroom exhaust fan is located either on the ceiling or high up on an outside wall, and a grille or shallow box covers it. The switch for the fan is usually either the same as the light switch, or located beside it. The bathroom fan exhausts air through the outside wall or roof via an insulated duct.

Your bathroom fan may be fitted with a timer so that it can be left on for a set time as needed.

Your bathroom may be equipped with a humidistat — a humidity sensor — which automatically triggers the fan to come on when the humidity reaches a set point.

Shallow metal hoods cap the exhaust ducts where they exit the house. At the point of exit, a damper (just inside the duct) or a cover (flap or louvres over the mouth of the duct) opens when the fan is operating and closes when it is not. In this way, heat loss from the house is prevented when the fan is off.

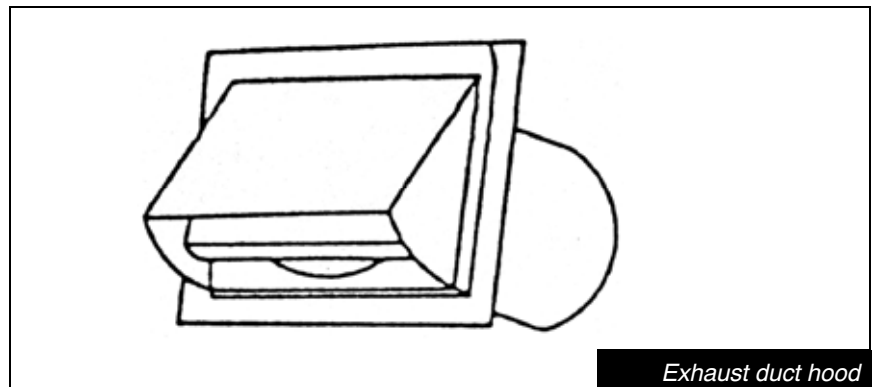

Exhaust duct hood

Operation and Maintenance

Use your fan or fans whenever activities in the kitchen or bathrooms are creating humidity or odours, or whenever the air smells stale. (See *The Environment in Your House*, page 17, to learn more about the need to control humidity in the house.)

Exhaust Fans

In winter, occasionally check the outside duct openings to ensure that the damper or cover has not frozen shut. (See *Troubleshooting* for guidance).

Stove hood fan

The metal screen under the stove hood is easily removed. Take it out periodically and clean it in soapy water. Oil build-up will clog the screen over time, reducing the effectiveness of the fan and creating a potential fire hazard.

If your stove hood has a recirculating, rather than an exhaust, fan, replace the charcoal filter at least once a year, and more frequently if the stove is heavily used.

Bathroom fans

If the bathroom fan is controlled by the same switch as the light, it will usually operate whenever the bathroom is in use. However, if you control the bathroom fan from a separate switch, be sure to turn it on whenever excess humidity is being created, particularly during hot showers or baths.

Periodically brush the fan cover or wash off accumulated dust. Once a year, in winter, check for drafts entering through the fan duct. Simply wet the back of your hand and hold it up to the fan: if you feel a draft, it is time to act; see the *Troubleshooting* section.

**Builder's or
Homeowner's Notes**

VENTILATION SYSTEM: HEAT RECOVERY VENTILATOR

Troubleshooting

HRV is not operating: Remember that some HRVs are very quiet. If you are not sure that yours is operating, hold a tissue up to one of the exhaust grilles to check for air flow. If the HRV is not operating, check first that it is plugged in and turned on at the control panel. Next check that the breaker is set at the "ON" position at the electrical panel (*General Information*, page 167). If the breaker trips again after being reset, it may have short-circuited. Call an electrician.

HRV is on but there is little air flow: Try the following steps, in order:

- Check the speed control setting on the central control panel.
- Make sure that nothing is blocking intake and exhaust openings on the outside wall, or the grilles on duct openings inside the house.
- Check that the filters are clean.
- Check that the heat exchange core is not frozen.

If none of these measures has corrected the problem, there may be a disconnected duct. If you are unsure of how to address this problem, call a service contractor.

Frozen heat exchange core: Turn off the HRV at the control panel, open up the HRV unit and let it defrost. If the system has an automatic defrost, the mechanism may need adjustment. Call a service contractor.

Air is stale or too humid: Set the HRV to the highest speed and check for proper air flow at the intake and exhaust. Check also for a frozen heat exchange core. If a dehumidistat controls your HRV, check the manual to determine how to set it to come on at a lower

Description

Modern houses are made airtight to reduce heating costs. However, without a regular exchange of air between indoors and outdoors, air quality and humidity problems can develop. The heat recovery ventilator (HRV) is an energy-efficient ventilation device that exhausts stale, humid air from the house and replaces it with fresh outside air. It recovers heat from outgoing air and transfers it to incoming air.

The HRV is mounted in a metal box, usually near the furnace. The HRV has four components:

- **Heat exchange core:** here the heat is transferred from the outgoing to the incoming air.
- **Fans:** circulate the air through the HRV.
- **Filters:** clean the air before it enters the core.
- **Defrost mechanism and drain:** remove condensation and ice build-up from the core.

The HRV's insulated exhaust and intake ducts penetrate the outside wall of the house, with the outside intake being placed at least one metre from any exhaust openings, to prevent stale air from being drawn back in.

- Your HRV fully meets the ventilation requirements for your house.

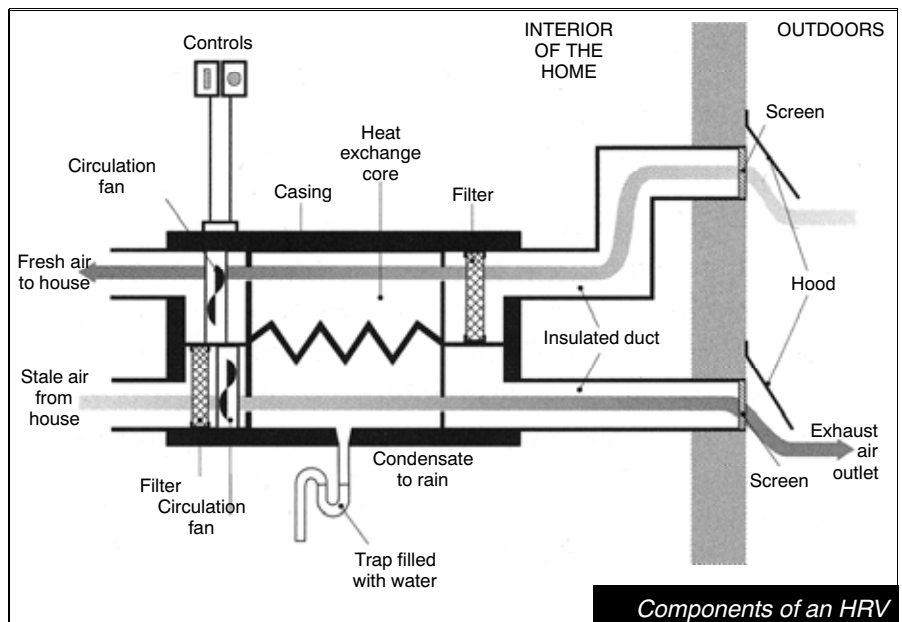

Heat Recovery Ventilator

Troubleshooting Cont'd.

humidity level. If you suspect a problem with the dehumidistat itself, call a service contractor.

Air is too dry in the winter: Dry air can cause cracked wood, dry sinuses, frequent colds and other respiratory problems. Adjust the dehumidistat, set the unit at the lower speed or operate the HRV intermittently, rather than continuously.

Additional Tips

- 🌳💰 To save energy and money, operate your HRV at the lowest speed required to ensure good indoor air quality.
- 🌳💰 To prevent over-ventilation in the summer, turn the dehumidistat to "OFF" or to the highest setting.
- ♥️ Check to see whether each room connected via ductwork to the HRV system is receiving the right amount of fresh air. Twist a wire coat hanger into a rectangular shape, and tape the open end of a regular-sized (66 cm x 91 cm or 26 in. x 36 in.) plastic trash bag around the wire. Gently deflate the bag and place its mouth over the grille of the duct that delivers air to the room. Time how long the bag takes to fill with air. Under average conditions, an air flow of five litres per second is recommended for most rooms: at this rate of flow, it should take about 13 seconds to inflate the bag. Master bedrooms should have an air flow of ten litres per second: at this rate of flow, the bag should take about eight seconds to fill. If the bag takes much longer to fill, you should

- In addition to the HRV, there are supplemental *Exhaust Fans* (page 134) located in the kitchen and one or more bathrooms.

Your HRV removes stale air via:

- the return air ducts of your *Forced Air Duct System*; or
- a set of ducts used only for the HRV, usually leading from the kitchen and bathrooms.

Your HRV draws in fresh air and delivers it:

- to the return air duct of the furnace and, thereafter, throughout the house via the existing hot air ducts of your *Forced Air Duct System*; or
- to the living spaces via a set of ducts used only for the HRV.

The main switch for the HRV is usually centrally located, often at a panel near the *Thermostat* (page 132): it should be labelled "VENTILATION FAN." There may be additional HRV controls in the kitchen, bathrooms or at other locations. (See *Operation and Maintenance*.)

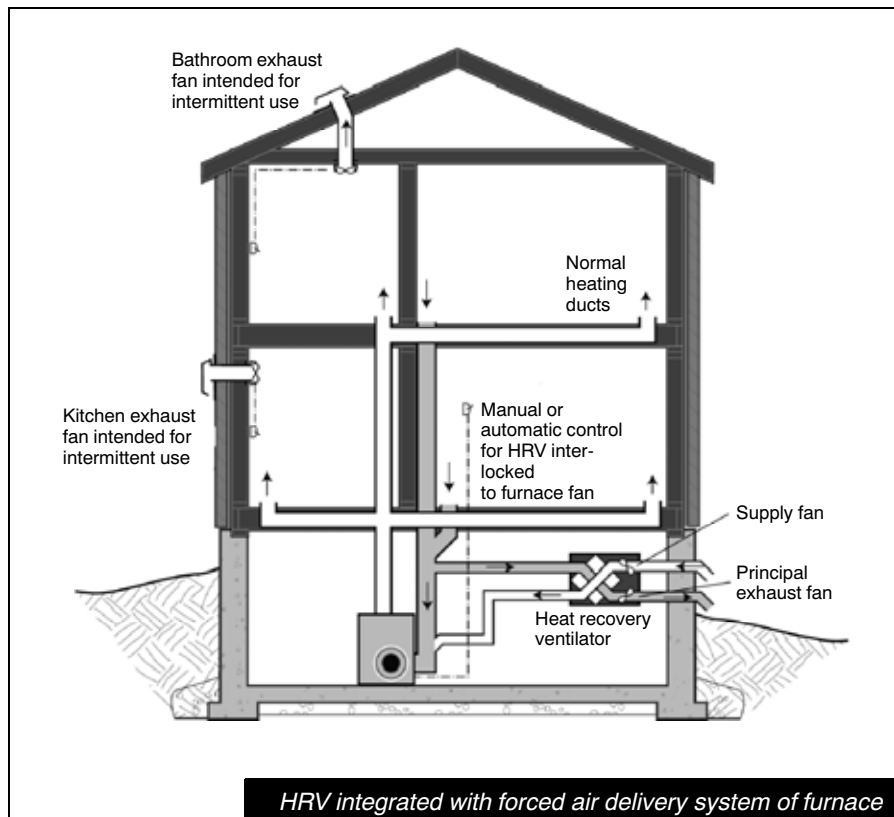

**Additional Tips
(cont'd)**

consider increasing the air flow.
(See the information on adjusting
grilles and duct dampers in *Forced
Air Duct System*, page 130.)

Do not connect a clothes dryer to
the HRV system.

In doing outside renovations or
landscaping, remember to keep the
outside air hoods clear of
obstruction.

Operation and Maintenance

Use your HRV! Properly operated, it is a reliable and cost-effective way to ensure good indoor air quality year round.

Run the HRV at a high speed during the first year after construction of your house, while the house is drying out and products used in construction are “off-gassing” (releasing volatile compounds). Similarly, turn the ventilator on high after major renovations or the installation of new synthetic carpeting or furnishings.

At other times, the HRV’s rate of air exchange should be set to suit household size and lifestyle. High-speed operation is recommended when: the number of occupants is high (e.g., during a party); the kitchen or bathrooms are occupied; tobacco, strong-smelling cleaners, paints or solvents are being used; or the air quality is noticeably poor. Low-speed operation is recommended at other times. If the number of occupants is typically small, or the house is vacant for extended periods during the day, the HRV can operate intermittently and even be turned off during the summer, if the windows are frequently open; but remember, your HRV will provide better overall air quality control than you would get using the windows for ventilation.

- The HRV controls are completely manual: you choose when to run the ventilator and at what speed.
- A timer in your bathroom(s) lets you turn the HRV on for a set time to ensure good ventilation of humid air during showers or baths.
- At the control panel, you can set your HRV to operate at either high- or low-speed at pre-set times when household members are likely to be doing things (e.g., cooking, showering) that release humidity, odours or pollutants into the house.
- Your HRV includes a dehumidistat, which will trigger the HRV when a given humidity level is reached. You can adjust the dehumidistat setpoint; and lowering the setting in cold weather will reduce condensation problems. If you have a humidifier, make sure that its humidistat is set at least 15 per cent lower than the HRV dehumidistat.

Every two or three months, clean the filters if they are washable, or replace them. Before removing the filters, turn off the power to the HRV at the control panel. To clean the filters, vacuum them first, then wash them in soapy water. At the same time, vacuum or brush any accessible surfaces around the filter and check that both intake and exhaust openings at the outside wall are functional and that they are not blocked or covered. Replace washable filters every few years. Some HRVs have a warning light at the control panel, or on the HRV itself, which comes on when the filter or other components need cleaning or service.

Heat Recovery Ventilator

Clean the heat exchange core twice a year, as recommended by the manufacturer. If there is a condensate (drip) pan in the HRV, clean it as well and pour a litre of water into the drain to check that it is free-running. Also, clean the grilles at duct openings and any accessible sections of the ducts themselves.



Information on the operation and maintenance of the HRV ductwork and grilles is given in *Forced Air Duct System*, page 130. If your HRV kitchen exhaust grille has a grease filter, clean it regularly.

Have a heating and ventilation specialist service the HRV every year, at the same time that the furnace is serviced. Servicing should include an air balance test, as well as checking the ductwork and operation of the HRV (including fan motors, filters, defrost system, condensate drain and controls). In a well-balanced system, as much air should be entering as exiting.

Builder's or Homeowner's Notes

For More Information

Operating and Maintaining Your Heat Recovery Ventilator. Natural Resources Canada, Home Heating and Cooling Series #8.

PART TWO

PLUMBING AND HOT WATER

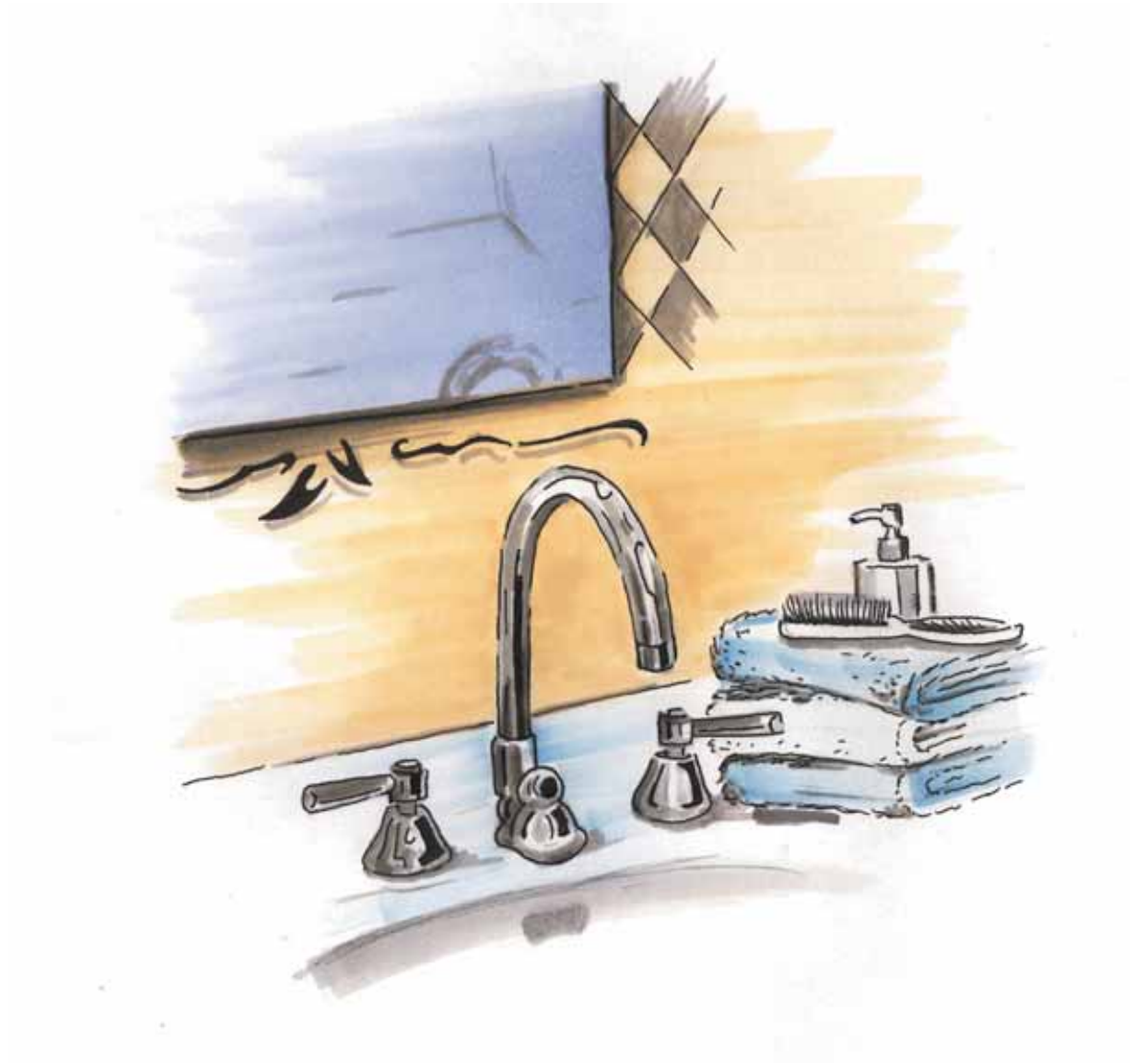

GENERAL INFORMATION

Troubleshooting

Noisy pipes: A loose pipe in the system may vibrate noisily when you turn the water off. Check to see whether you should tighten or replace the clamps or hangers that hold the pipe in place. A slow leak associated with worn washers can also make noise when you turn the water on (*Faucets*, page 149). A loud banging known as water hammering results from the sudden closing of a mechanical quick-acting valve on an appliance (for example, a washing machine). Speak to your builder or consult a home repair book or a plumber about installing a water-hammer arrester. Correct all these problems quickly to avoid damage to plumbing connections and valves.

Frozen pipes: If the supply pipes freeze, soak rags in hot water and wrap them around sections of exposed pipe, or use a hairdryer. Start with sections of pipe closest to the faucet. Leave the faucets open during thawing to allow steam and meltwater to escape. For hidden pipes, use a space heater set at a safe distance from the wall. If the drain pipe has frozen, pour hot water down the drain. If this fails, apply low heat along the pipes, as with the supply pipes.

 While a frozen pipe is thawing, steam can build up and burst the pipe. Thaw pipes slowly or leave the job to a professional plumber.

A small leak: As a temporary solution, wrap plastic or duct tape tightly around the leaking section of pipe. If you suspect a hidden leak, go and look at the meter, which may have a window with a dial showing consumption. If you have a leak, the needle on that dial will be moving, even if no plumbing fixtures are being used. Call a plumber to find and fix the leak.

System Overview

The plumbing system in your house consists of:

- plumbing fixtures (toilets, sinks, bathtubs, etc.);
- the water supply system (which brings fresh water to each fixture); and
- the drainage system (which removes wastewater and sewage from the plumbing fixtures).

The water supply comes into your house from a **Well** (page 162) located on your property or from a **municipal water main**, usually buried under the public roadway. A water meter, located outside where the water line enters the house, records the quantity of water used by the household. Electronic metering is now common, and municipal staff can read the meter without visiting the property.

Your house may also have a **cistern** (tank) — not connected to the plumbing system — where rainwater collects for non-potable uses, such as watering your garden.

Shut-off Valves (page 144) are built into your water supply system at various points for use during emergencies (e.g., leaks) or during plumbing repairs.

The drainage system collects wastewater from all your plumbing fixtures. In case of flood, water also flows into a drain in the basement floor (*Drains and Traps*, page 151). Wastewater from your household discharges to a **Septic System** (page 164) or to a **municipal sewage line**. If you have a **pump** in your basement, it drains wastewater from any plumbing fixture that stands lower than your house's drainage exits. This pump may be automatic or may be turned on at a wall switch, as needed.

Your drainage system has a number of clean-out plugs: these are short sections of pipe with removable caps that provide access to the system to clear out blockages. Clean-out plugs are usually found in the basement on the street side of the house or, for houses in the country, on the wall where the main drainage line goes through to the **Septic System**. There is also a clean-out plug on the main sewage line leaving the house.

Venting equalizes the air pressure in the system and prevents water from being siphoned out of the traps (*Drains and Traps*, page 151) and toilets. Each fixture vents to one of the vent stacks going through the roof.

The discharge from storm water and weeping tile (*Foundations*, page 50) is not part of your wastewater system, and may drain to a

General Information

Troubleshooting Cont'd.

A burst pipe: As a temporary solution, wrap a piece of neoprene rubber around the cracked section of pipe and secure it with several closely spaced, screw-tightened hose clamps. Call a plumber to replace the pipe section.

Additional Tips

In an emergency, knowing where to find your house's *Shut-off Valves* (page 144), especially the main shut-off, is important. Label the main shut-off valve and show everyone in the household where to find it and the other shut-off valves.

If the water supply is going to be interrupted for very long, turn off your *Hot Water Tank* (page 146). Trying to heat a partially filled tank can damage it.

A back-flow preventer (backwater valve) is a simple device that fits into the basement floor drain and prevents flooding from water surges in lines outside the building. Contact your municipality to see if it recommends a back-flow preventer.

specially designed pit on your property or the municipal storm water sewer.

- Generally, you are responsible for the water and sewage lines on the property.

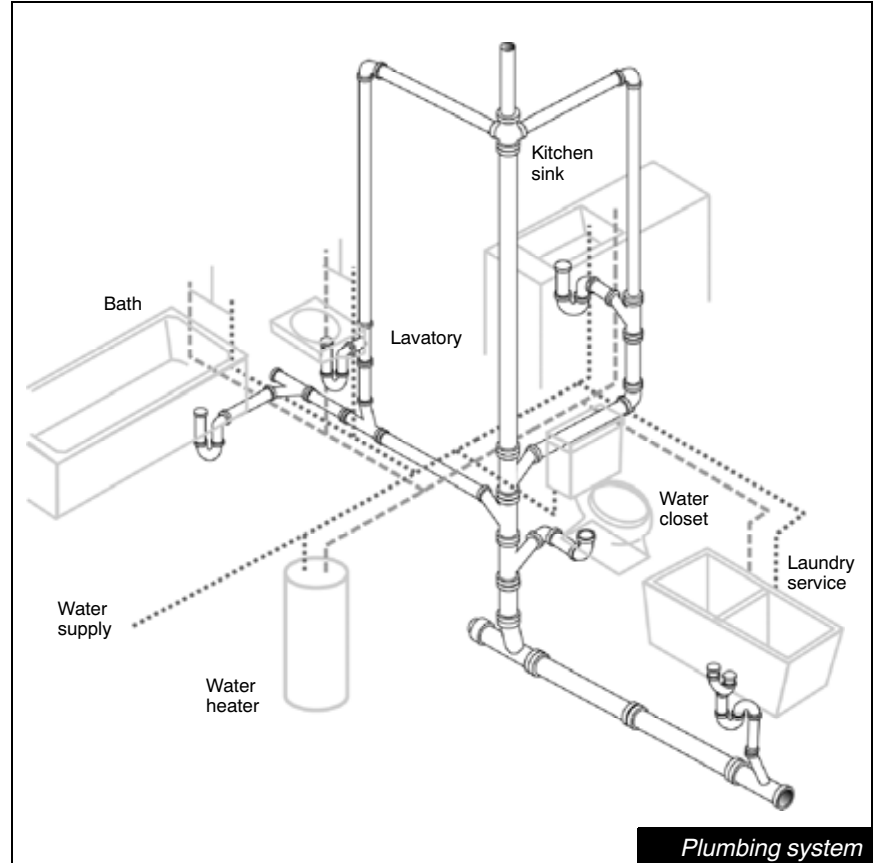



Care and Maintenance

Put no sanitary products, other than toilet paper, down the toilet. Prevent large particles of food, hair or other solids from going down the drain. Never pour grease, fat or petroleum products down the sink: these will accumulate over time and block the drains.

Make sure that you can easily reach plumbing *Shut-off Valves* (page 144) and drain clean-out plugs. In particular, if you plan to finish the basement, make sure that you build access panels — at least 30 cm x 30 cm (12 in. x 12 in.) — for the shut-off valves and clean-out plugs. Also, keep a pathway open to the meter at all times of year.

Never leave your house completely unheated during sub-zero weather. If the house freezes, your pipes, hot water tank and toilets may burst, causing a flood. Similarly, leave at least a little heat on in any room with

**Additional Tips
(cont'd)**

  The average Canadian uses 390 litres of water a day at home, mostly for showering and flushing toilets. Wasting water is costly — to the municipality, to the environment and, ultimately, to you. Many municipalities bill homeowners for water according to actual use. However, even if you are not billed directly for water consumption, water supply and wastewater treatment consume a large part of your municipal taxes. Fix leaks promptly, do not run taps unnecessarily, and consider installing water-conserving fixtures and appliances (*Faucets*, page 149 and *Toilets*, page 157).

plumbing, even if the room is unused (*A Safe and Secure Home*, page 26).

**Builder's or
Homeowner's Notes**

Location of cistern.

Location of basement pump and switch and, if it is not automatic, how to work it.

Location of clean-out plug on main sewage line.

SHUT-OFF VALVES

Troubleshooting

Fixture or equipment shut-off valve not working: In an emergency (e.g., if the fixture is flooding) or for quick repairs, turn off water to the whole house at the main interior shut-off valve. If the malfunctioning valve has seized, apply oil at the base of the tap. Otherwise, call a plumber.

Main interior shut-off valve not working: In an emergency, if the main interior shut-off valve does not work, contact your municipal or regional government to close the municipal shut-off valve. Call a plumber to check the main interior shut-off valve.

 For water problems, the emergency phone number may be listed under municipal government services.

Description

Your plumbing system has a number of shut-off valves built into it at various points. In case of emergency, or during plumbing repairs, you can turn off the water supply at these valves.

Your water supply system has the following shut-off valves:

- **Municipal shut-off valve:** This valve is generally found near the property line. Only the city can turn off the water at this valve.
- **Main interior shut-off valve:** This valve is on the main water line and usually in the basement, where the line enters the house.
- **Fixture valves:** These are found behind toilets, under sinks and near washing machines (*Drains and Traps*, page 151). Most fixtures have individual shut-off valves so that they can be repaired without shutting off water to the whole house.
- **Other valves:** These include valves for the *Hot Water Tank* (page 146) and *Outside Faucet* (page 149) and for special equipment.

Operation and Maintenance

To turn off the water at most shut-off valves, simply rotate the handle or tap. However, to operate a ball valve, pull up the handle until it is perpendicular to the pipe. Valves, if they are unused for long periods of time, may tend to stiffen or seize up entirely. Once or twice a year, turn all the valves in your house off, then on again.

Additional Tips

In an emergency, knowing the location of the house's shut-off valves, especially the main shut-off, can be important. Label the main shut-off valve and show everyone in the household where to find it.

Maintain free access to plumbing shut-off valves. For example, if you plan to finish your basement, build access panels — at least 30 cm x 30 cm (12 in. x 12 in.) — for all shut-off valves.

If you plan to be away from home for a while, turn the water off at the main interior shut-off valve.

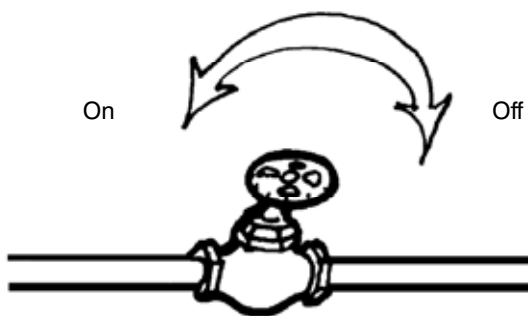

Handle for shut-off valve

**Builder's or
Homeowner's Notes**

Name and phone number of emergency water services or relevant division (for shutting off municipal water supply).

HOT WATER TANK

Troubleshooting

A stain or water on the floor under the pressure relief valve: Any indication that the relief valve has opened may mean that your tank occasionally exceeds its pressure or temperature rating. Call for service immediately.

Flooding from the pressure relief valve: Shut off the power or fuel, as well as the water supply, to the tank (*Operation and Maintenance*). Call for service immediately.

A leak from the tank: The leak may come from a loose connection or a crack or hole in the tank. If the tank is leaking badly, shut off the power or fuel supply to the tank (see *Operation and Maintenance*) and drain the tank from the valve at the bottom. If possible, connect a hose to the valve and direct the water to a floor drain. Have any leak, no matter how small, fixed immediately.

⚠ Never leave a hot water tank on unless it is completely filled.

⚠ Never drain an electric tank without first cutting off the power. Most new hot water tanks, no matter what kind they are, use at least some electricity. If a circuit breaker at the electrical panel is specified for the hot water tank (*Electrical System*, page 167), set it to "OFF" while the tank is draining.

Lack of hot water: The power supply to your tank may have been interrupted. Check for a tripped breaker on your electrical panel (*Electrical System*, page 167). If you have an electric tank, push the reset button on the top thermostat. However, if the power is cutting out repeatedly, call for service. If you have a gas tank, check the pilot light (instructions for relighting it are displayed on the tank).

Description

Your hot water tank can be heated by **electricity, natural gas, propane or oil.**

⦿ The information on the natural gas hot water tank generally applies to the propane and oil tank as well.

Your hot water tank can be owned, rented or part of your house's space heating system (*Integrated Heating System*, page 115).

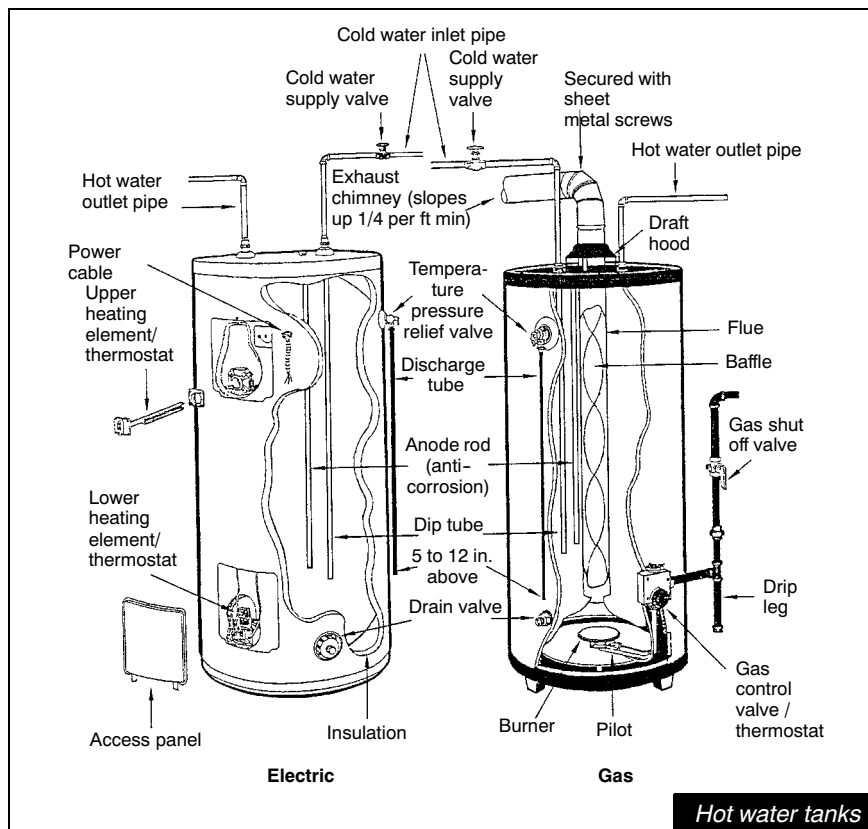

Operation and Maintenance

To shut down an electrically heated hot water tank, turn the specified circuit breaker to "OFF" at your electrical panel (*Electrical System*, page 167). If you have a natural gas tank, turn off the gas supply at the valve on the gas supply line (this usually connects to the tank at the

Troubleshooting Cont'd.

Frequently running out of hot water: Try rescheduling some of your hot water demands or install water-conserving devices (*Faucets*, page 149 and *Toilets*, page 157). Alternatively, you can raise the temperature setting on the tank, but there are some disadvantages to that (see *Additional Tips*).

Low flow from the hot water taps: There may be sludge blocking the line from the hot water tank (see *Operation and Maintenance*).

-  Can't solve a problem? If you rent your tank, call the fuel supplier; if you own it, call a plumber or electrician.

Additional Tips

 Keeping the water temperature at 55°C (131°F) or lower will reduce the risk of scalding, save on energy bills and be easier on your tank's lining. One place you need really hot water is the dishwasher: however, if your appliance heats its own water, the lower temperature of the water entering it should be acceptable. (Check the manufacturer's literature.)

 Save energy and money while away on vacation. Turn off your electric hot water tank at the electrical panel (*Operation and Maintenance*) or turn your gas tank to the "low" or "vacation" setting. Talk to your fuel supplier or tank manufacturer about other energy-saving ideas that make sense for you.

temperature control dial). Also, you can turn off the water supply to your tank (the shut-off valve is located at the top of the tank on the cold water supply pipe).

-  Never turn off the water supply to the hot water tank without first shutting off the power or fuel supply. Heating a partially filled tank could lead to an explosion.

You can control your hot water temperature. To change the temperature setting, you may need a flashlight and, for an electric tank, a screwdriver.

- In a gas-fired tank, a dial — usually at the bottom of the tank — controls the temperature setting.
- An electric tank usually has two elements, one on top and one at the bottom of the tank. Look for reset buttons and adjustable temperature settings under cover plates at each element.

-  Never change the temperature setting on an electric tank without first cutting the power supply to the circuit (see above).

A pressure relief valve, usually found near the top of your tank, connects to a rigid discharge tube hanging down the side. Normally, this valve is inactive; however, when the pressure or temperature in the tank exceed specified ratings, the valve releases water or steam. Test the valve occasionally by pressing the small lever. If the valve is in good working order, it will release a spray of water and, as you release the lever, will reset.

To limit the gradual build up of sludge at the bottom of the tank, periodically open the drain valve at the bottom of the tank and let the water flow until it runs clear.

Your tank has an eight- to twelve-year life expectancy. Cloudy or reddish water (and other problems listed under *Troubleshooting*) may mean that it is time to replace the tank; however, there are ways to extend the tank's life. At the first sign of trouble, try to slow down corrosion of the tank by replacing the anode — a long rod put in the tank to attract corrosion-causing impurities. If your tank is heated by gas, have the heating mechanism checked at the time of your regular furnace inspection.

**Builder's or
Homeowner's Notes**

- Your hot water tank is **owned**.
- Your hot water tank is **rented**.
- Your hot water tank is **integrated** to your house's heating system.

Location of tank. Fuel supplier name and phone number.

For More Information

Heating with Electricity. Natural Resources Canada, Home Heating and Cooling Series #2.

Heating with Gas. Natural Resources Canada, Home Heating and Cooling Series #3.

FAUCETS

Troubleshooting

Loose faucet handles: Usually, you can fix these by lifting the cap off the tap handle and tightening the screw that attaches the handle to the stem assembly.

Dripping faucets: Generally, you can fix a leaky stem faucet by replacing worn washers or faucet seats. If water is leaking from the handle, you should probably replace the packing washer or O-ring near the top of the stem. Use a pre-packaged repair kit to fix single-lever faucets, or install a new cartridge. Most home repair manuals offer step-by-step guidance for such simple repairs. Alternatively, consult the installation and repair manual for the fixture in question. Always shut off the water supply to the fixture before repairing it (*Shut-Off Valves*, page 144).

When you turn off the shower in a combination tub/shower, the waterspout normally drips briefly as the water drains out of the shower pipe.

Bathtub spout leaking during shower use: The shower diverter on the combined tub/shower spout is not working properly. Buy a replacement part at a hardware or plumbing supply store.

Noisy faucets: Loose washers can cause noisy vibrations (*General Information*, page 141).

Poor water pressure: The problem may be a clogged aerator screen. Before removing and cleaning it, close the drain plug to prevent parts from going down the drain. Then unscrew the aerator cap at the end of the faucet spout or shower nozzle. Disassemble the cap and set the parts aside in order of removal. Clean the screen by soaking it in vinegar and scrubbing it with an old toothbrush. Reassemble the parts, screw the cap into place by hand and tighten 1/4 turn with pliers.

Description

Though sink, bathtub and shower faucets come in a variety of shapes and sizes, there are only two basic types: stem faucets (with two handles controlling water flow and temperature, and washers to prevent leaking from moving parts); and single-lever faucets (only one handle). Single-lever faucets can be further divided into two types: ball faucets (featuring a brass ball with holes that the handle moves into position over the cold or hot water delivery pipe); and cartridge faucets (where the moving parts controlling water flow and temperature are contained within a cartridge).

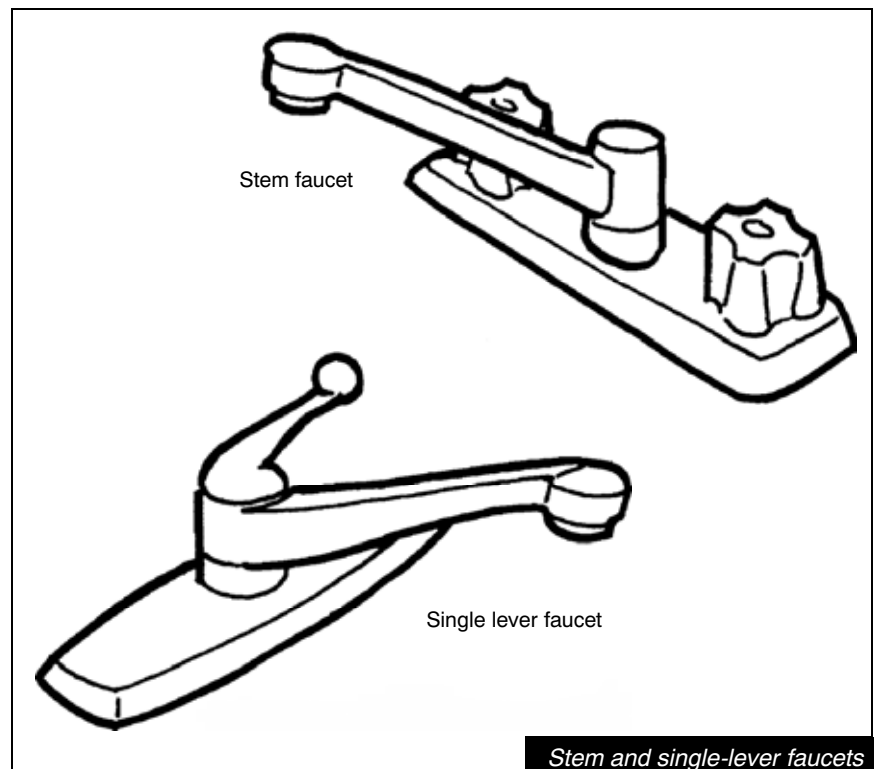

Your sinks may be equipped with water-conserving faucets that reduce water consumption while maintaining a forceful spray. These faucets save water, energy and money; however, they fill the sink a little more slowly.

Your showerhead may be equipped with a low-flow device that reduces water consumption while maintaining a forceful spray. There may be a small lever on the side of the showerhead that you can use to reduce or shut off the water flow for a moment during a shower. Use the main

Additional Tips

Hardware, home renovating and department stores all offer a wide range of easy-to-install water-conserving showerheads. Look for the EcoLogo (*The Environment in Your House*, page 17) as a guarantee of the product's environmental value.

Use masking tape to cover any parts of the chrome finish where pliers will be used. Alternatively, wrap the jaws of the pliers with tape.

controls, rather than this lever, to turn off the water at the end of a shower.

Your shower may be equipped with a pressure balance valve, which keeps the temperature constant even when another fixture (e.g., the toilet) is drawing water.

Your *Outside Faucet (Hose Bib)* is described on page 160.

Operation and Maintenance

When turning water off at the faucet, do not force the handles or you may damage the washers, causing the faucet to drip or leak. Turn the handles just enough to stop the water flow.

Many fixtures have their own *Shut-off Valve* (page 144). For example, sinks usually have shut-off valves right underneath the basin. When you want to repair fixtures, use these instead of the main shut-off valve, which will cut off water to the whole house.

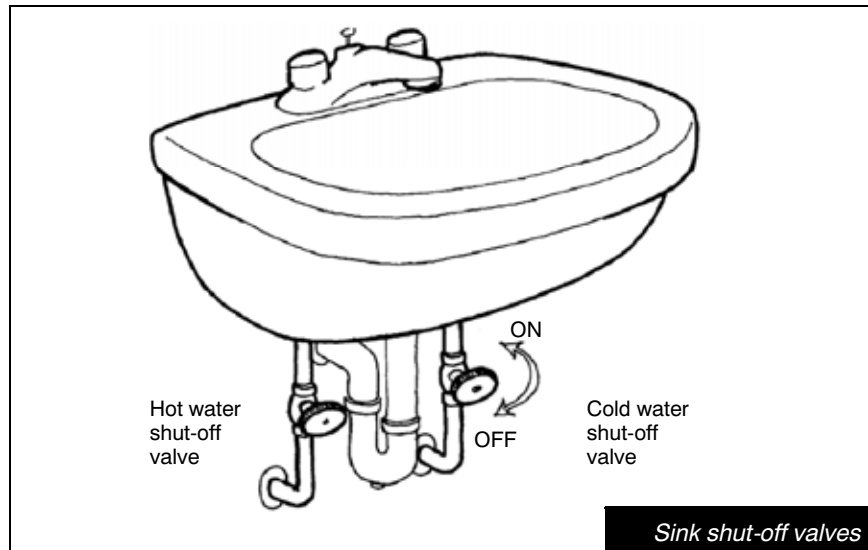
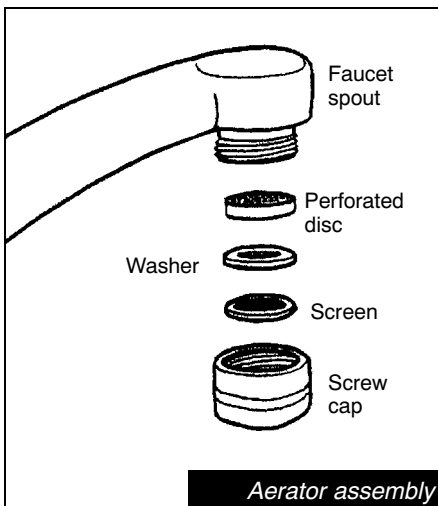

DRAINS AND TRAPS

Troubleshooting

A sewer smell in the basement:

Water may have evaporated from your basement drain trap (see *Operation and Maintenance*). Similarly, if you have a laundry tub or any other plumbing fixture that you do not use often, the trap may dry out. Briefly turn on the water and let it drain through the fixture.

Valuables down the drain: If you plug the drain and stop the flow of water quickly enough, the item may not be washed through the trap. Some traps have a clean-out cap positioned over a small hole at the bottom of the U. Put a bowl or bucket under the trap, then unscrew the cap, using a wrench if necessary. If there is no clean-out cap, unscrew the coupling nuts at either end of the U and remove the trap itself.

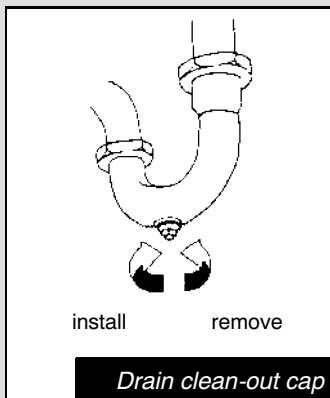

A blocked drain: First, try manually removing debris at or near the drain opening. Lift out the drain plug (for push button and pop-up drain plugs, see the next page) and remove anything caught on the cross bars inside the drain. If this does not work, try removing the blockage through the trap, or use a plunger (see instructions on following page). Once the drain is partly opened, very hot water (maximum 60°C or 140°F) will often complete the job.

Description

Drains are pipes that remove wastewater. Some drains attach to fixtures, while others are set in the floor and drain low parts of the house. For example, there is a drain in the basement floor, usually in the utility area near the hot water tank.

Every drain has a trap (a U-shaped section of pipe not far below the mouth of the drain). The shape of the trap is such that it forms a reservoir of water to prevent sewer gases and bacteria from entering the house via the pipe. Every time the fixture is used (a sink emptied or toilet flushed), new water replenishes the trap.

Operation and Maintenance

Put nothing down the drain (e.g., hair, large food particles, grease) that the fixture is not designed to handle. Follow this advice and you will avoid blocking the plumbing or overburdening the sewage treatment system.

Periodically remove the drain plug (stopper) from the drains in your fixtures and remove any debris that has collected on the plug or on the cross bars just inside the drain. For advice on how to remove pop-up and push-button plugs, see the following page. If you have a shower, remove and clean the shower drain screen from time to time, along with the screen from the basement floor drain. Use an old toothbrush to clean plugs and screens.

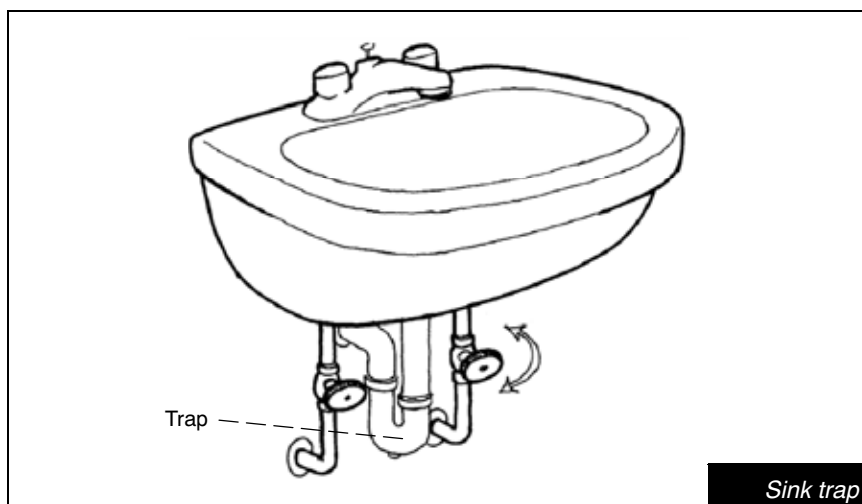

Troubleshooting Cont'd.

Corrosive agents are a last resort, as they can damage the pipes and any surface they splash on: use them to open a blocked drain only after you have tried everything else. Do not use caustic soda to open a drain: caustic soda can combine with grease or food waste to form an insoluble compound, a source of future blockages.

- ⦿ If more than one drain in the house is sluggish, the blockage is probably in a main drainage pipe. Call a plumber.

Because the basement floor drain is mostly unused, the water in the trap may eventually evaporate. To prevent this:

- Your basement floor drain has a mechanical trap primer: this is a small water line that runs under the floor between a water pipe (usually the pipe is attached to a nearby plumbing fixture) and the trap. When you run water in the nearby fixture (e.g., a laundry tub), the primer lets enough water trickle into the drain to maintain the trap.
- Every three to six months, pour a bucketful of water into the basement floor drain trap.

Instructions for removing push button and pop-up drain plugs:

The push-button drain plugs that are common to many bathtubs are easy to remove. Simply push the button so that the drain is open, then unscrew the drain plug counterclockwise. Pop-up plugs are also easy to remove. Below the sink, the pivot rod that moves the plug clips to a vertical rod with holes in it (a clevis rod). Squeeze the clip and slide out the pivot rod. If necessary, first loosen the nut at the back of the drain with an adjustable wrench. Now lift out the stopper, clean it with a stiff brush and reinstall it. At the same time, replace the O-ring on the stopper, if it is worn.

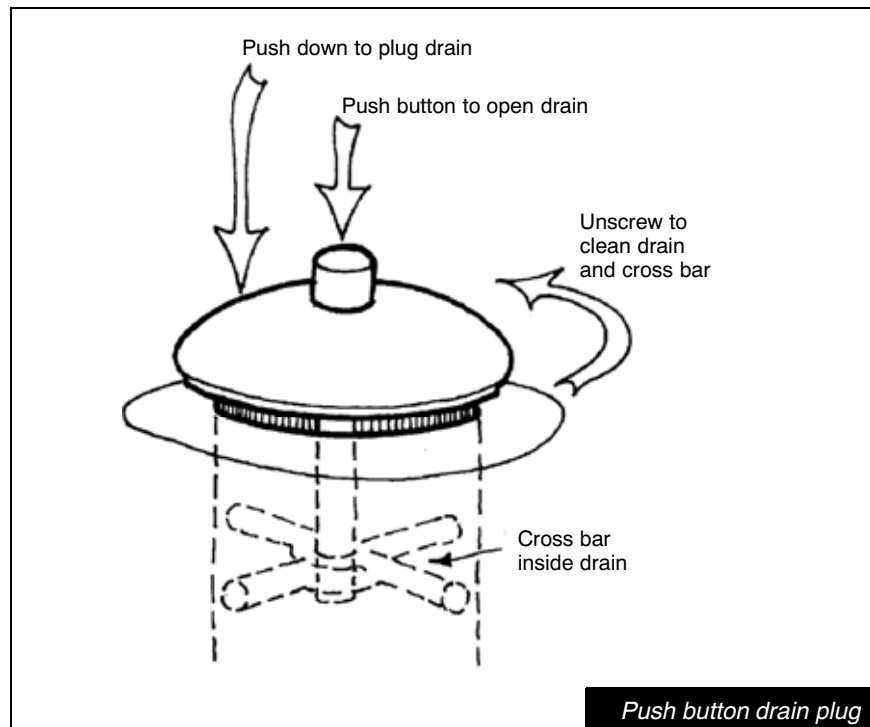

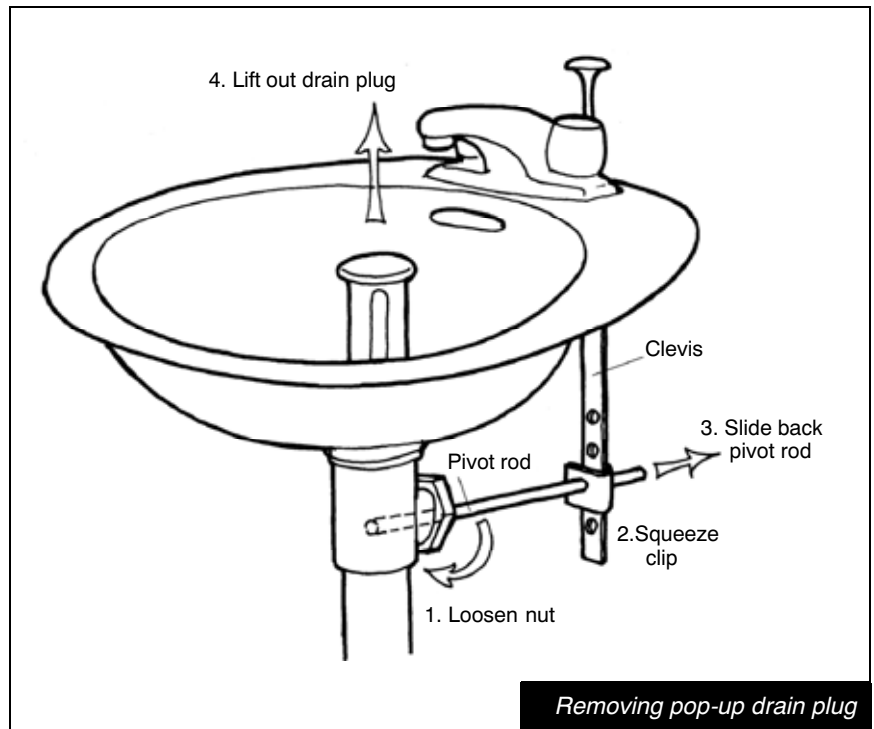

Instructions for removing a blockage through the trap:

If the trap has a clean-out cap at the bottom of the U, place a bucket under the trap and unscrew the cap: if only a little water flows out, the blockage is above the trap; if water flows freely from the hole, the blockage is further down the pipe. Probe with the hook end of an opened-out wire coat hanger to free the blockage. Alternatively, remove the trap and use a drain auger or plumber's snake to probe for the obstruction. Consult a home repair guide for step-by-step guidance.

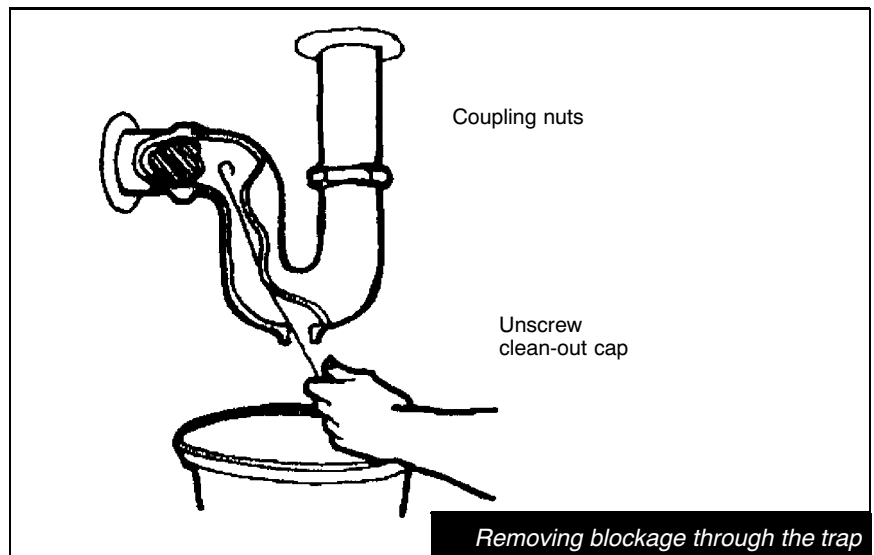



If you recently used chemical cleaners on the drain, remnants of chemicals may remain. Wear rubber gloves to protect your hands when plunging or probing for an obstruction.

Instructions for plunging a blocked drain:

If the fixture has an overflow (as in a bathtub or sink), block it tightly with a wet rag. If the fixture is a double sink, close the second drain; and, if there is a dishwasher connected, use a C-clamp to sandwich the drain pipe hose between two blocks of wood, thus closing it. Remove the drain plug and place the plunger over the drain opening. Fill the sink or tub enough so that the base of the plunger cup is underwater. Plunge 10 to 20 times in succession, pushing down smoothly and pulling up sharply but without breaking the plunger's seal. On the last stroke, abruptly lift the plunger out of the water.

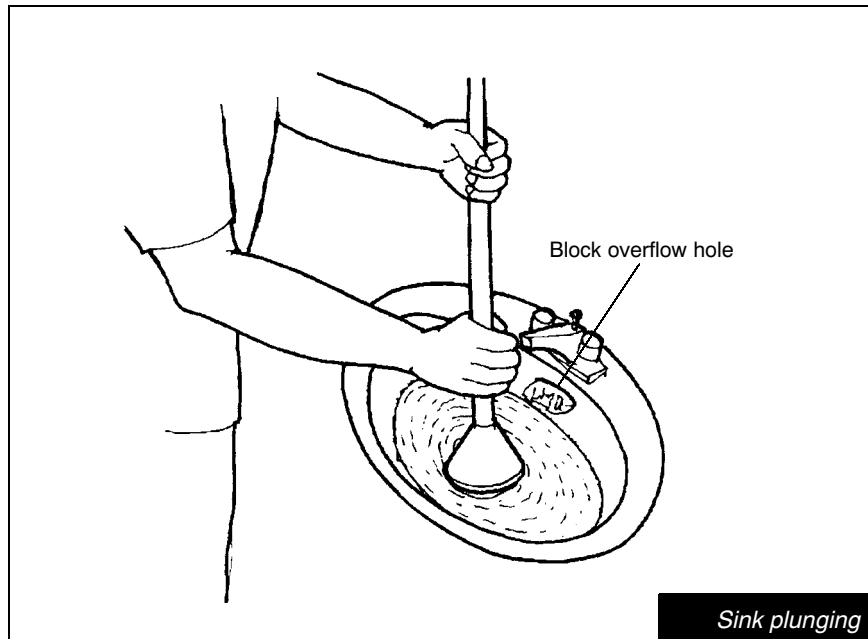

**Builder's or
Homeowner's Notes**

BATHROOM SINKS, TUBS AND SHOWER ENCLOSURES

Troubleshooting

A water leak under the bathroom: There are several possible causes:

- Water may be splashing on to the floor outside the tub.
- There may be too much condensation on ceilings, walls and around the base of the toilet. (To reduce condensation, see the *Troubleshooting* tip on mold.)
- The caulking may have failed at the edge of the tub or where plumbing fixtures penetrate the floor or walls; or there may be cracks and gaps in the tiles and grout (*Operation and Maintenance*).

If none of the above is causing the problem, you may have a plumbing leak. Call a plumber.

Molds in the bathroom: The warm damp environment of the bathroom offers a near perfect habitat for mold, and they are especially common above the tub and shower and around windows. As a first principle, to get rid of mold you have to get rid of excess humidity:

- Use the *Exhaust Fan* (page 134) during baths and showers.
- Wipe condensation from the tiles after bathing and spread out wet towels for fast drying.
- Decontaminate with a solution made from one part chlorine bleach to two parts water and add just enough dishwashing liquid to attack surface grime and oil. If the area is very moldy, apply pure chlorine bleach or a commercial mildew remover, keeping the surface moist for at least 15 minutes; then wash with the bleach-water-soap solution and dry rapidly to prevent new mildew growth.

Description

The enclosures around the bathtub, shower and sink are designed to protect the surroundings, including walls, from water damage. Caulking (a flexible filler) seals all seams and prevents water damage at the junction of walls, floors, countertops and fixtures. Grout (a hard cement filler) seals the joints between ceramic tiles. The shower is built to prevent water from running onto the bathroom floor; however, where a curtain rod is provided, install a curtain before using the shower.

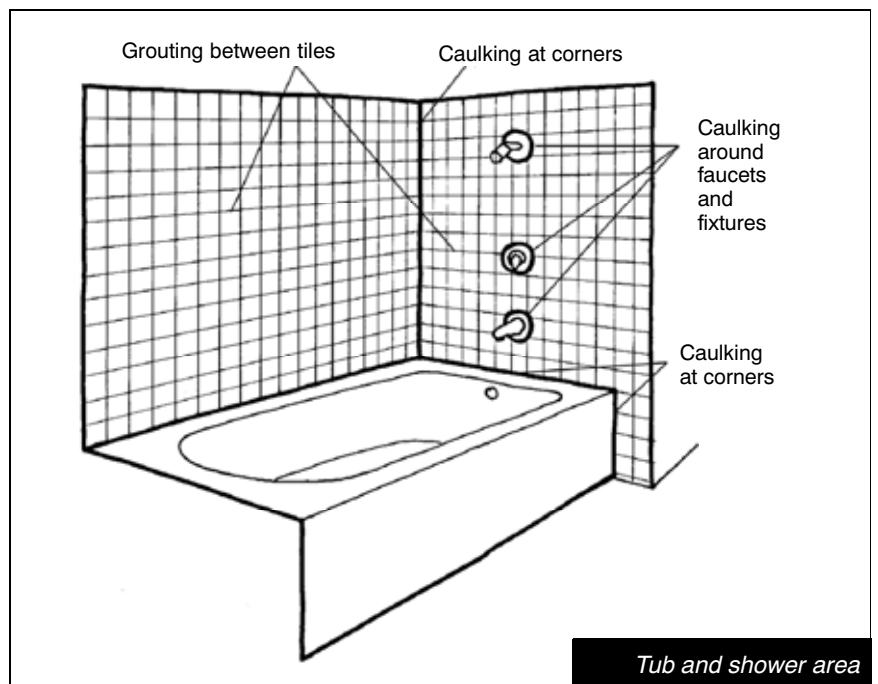

See *Drains and Traps* (page 151) and *Faucets* (page 149) for more information on bathroom plumbing.

Operation and Maintenance

To protect the finishes on your bathroom fixtures:

- Use non-abrasive cleaners. Though bathroom finishes are designed to be attractive and easily cleaned, abrasive materials can scratch them.

Bathroom Sinks, Tubs and Shower Enclosures

Troubleshooting Cont'd.

Mineral build-up and soap residue: Clean with a commercial glass cleaner.

- Avoid harsh chemicals. Certain chemicals (e.g., photo-developing solutions and some drain cleaners) stain finishes.
- Use plastic rather than glass or metal containers in the bathroom. When dropped, glass containers can shatter. Metal utensils, or anything made out of hard, heavy materials, can chip ceramic surfaces.

If you have a shower curtain, take it down from time to time and machine-wash it.

Check periodically for cracks or gaps in the grouting and *Caulking* (page 71) around the tub and shower. Remove damaged caulking and replace it with a high-quality, flexible, waterproof caulking that is suited to bathroom use, will cure within a few hours and is non-toxic. Apply caulking to clean, dry surfaces. Caulk around the tub while it is filled with water to ensure that the caulking fills all the gaps at the edge.

Additional Tips



Especially if you have allergies or environmental sensitivities, avoid working with products containing strong solvents — for example, mildew removers, and some types of caulking and grout.



The following safety measures are recommended for the bathroom:

- Install tub mats and grab bars in bathrooms, especially those that children or the elderly are likely to use.
- Store medicines, cleaners and other chemicals away from the reach of children.
- Lower the hot water temperature setting on the hot water tank to avoid the risk of scalding (*Hot Water Tank*, page 146).

Builder's or Homeowner's Notes

TOILETS

Troubleshooting

Water dripping from the base of the tank: Condensation on the tank may cause the tank to drip (see *Operation and Maintenance*). Alternatively, a loose joint between the tank and bowl—indicating that the washer has failed—might cause the tank to leak. Turn off the water at the toilet's shut-off valve and call a plumber.

Leakage around the base of the toilet: The wax seal between the toilet and the waste pipe may have failed. Turn off the water at the toilet's shut-off valve and call a plumber.

Water continuously spilling into the overflow tube: The ballcock may be faulty or clogged. The float may also be set too high for the water level; or, if the ballcock is sitting too low in the water, it may be leaking. All these problems can easily be remedied. Consult a home repair guide.

Water running continuously into the bowl: If the flap over the outlet is not closing properly, debris on the outlet "seat" may be preventing a proper seal. Turn off the water at the shut-off valve and flush the toilet to empty the tank. Then use a brush or steel wool to clean the rim and inner surface of the outlet seat. If this does not solve the problem, see if the chain is too short to allow the flap to seat properly over the hole. Again, empty the tank. If a clamping screw or hook connects the chain to a guide arm, move it about 10 mm (3/8 in.)—or one hole—along the guide arm. If the chain is too long, shorten it by removing a few links.

Toilet not flushing fully (or handle must be held down to flush): The chain or wire that lifts the flap off the outlet inside the tank may be too

Description

The toilet consists of a seat with a bowl beneath it, and a water tank with a flushing mechanism inside. Large bolts capped with plastic secure the toilet to the floor and to a wide flange (collar) over the waste pipe. Between the toilet and the pipe, a wax seal — which will normally last many years — keeps waste and odours from leaking. Toilets have *Shut-Off Valves* (page 144) on the water supply line, below or behind the water tank.

The flushing mechanism in the tank works as follows: the flush handle on the toilet attaches to a pull chain or rod in the water-filled tank. When the handle is pushed, the chain briefly opens a flap over an exit hole (outlet) at the bottom of the tank. The water swirls out of the tank and through the bowl, then flushes down through a water-filled trap into a wastewater line. As the level of water in the tank drops, a float ball drops with it, opening a valve (the ballcock) at the tank's water inlet: the tank begins to fill again. The float ball rises with the inflowing water until the ballcock returns to a position where it shuts off the tank's water supply. If the tank overfills, excess water flows into the bowl through an overflow pipe.

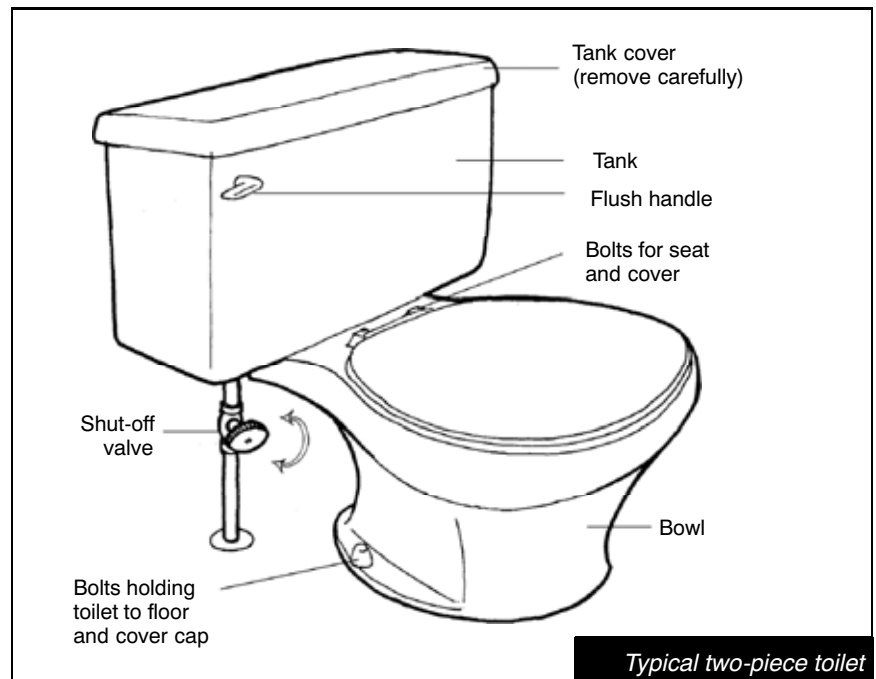

Typical two-piece toilet

Troubleshooting Cont'd.

long. See the previous *Troubleshooting* tip for instructions on how to adjust the chain length.

Toilet is blocked: A plunger is often the answer. If there is not enough water in the bowl to cover the rim of the plunger, pour more in: do not flush the toilet to fill the bowl. Place the plunger over the toilet opening and pump up and down about ten times, without breaking the seal. Pull up abruptly on the last pump. Repeat several times until the blockage clears. Consult a home repair guide for other options, or call a plumber.

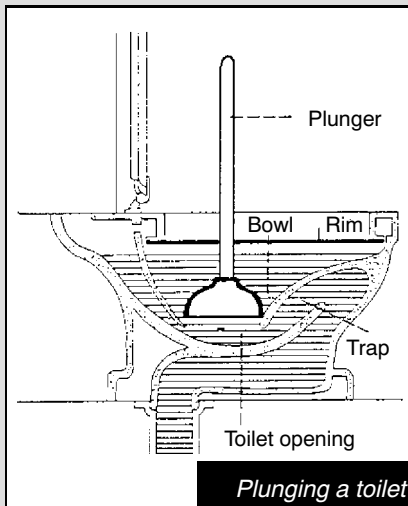

Toilet is loose at the floor:

Remove the caps from the nuts at the base of the toilet and tighten them carefully. Do not over tighten or you risk splitting the bowl.

Toilet seat is loose: Threaded bolts and nuts attach the toilet seat and its cover to the toilet through two holes behind the toilet bowl. Tighten the nuts by hand or with a wrench. Do not over tighten or you risk splitting the bowl.

Your toilets may be a low-flush type, designed to conserve water. Do not install other water-saving devices (e.g., tank dams) in this type of toilet without consulting the manufacturer.

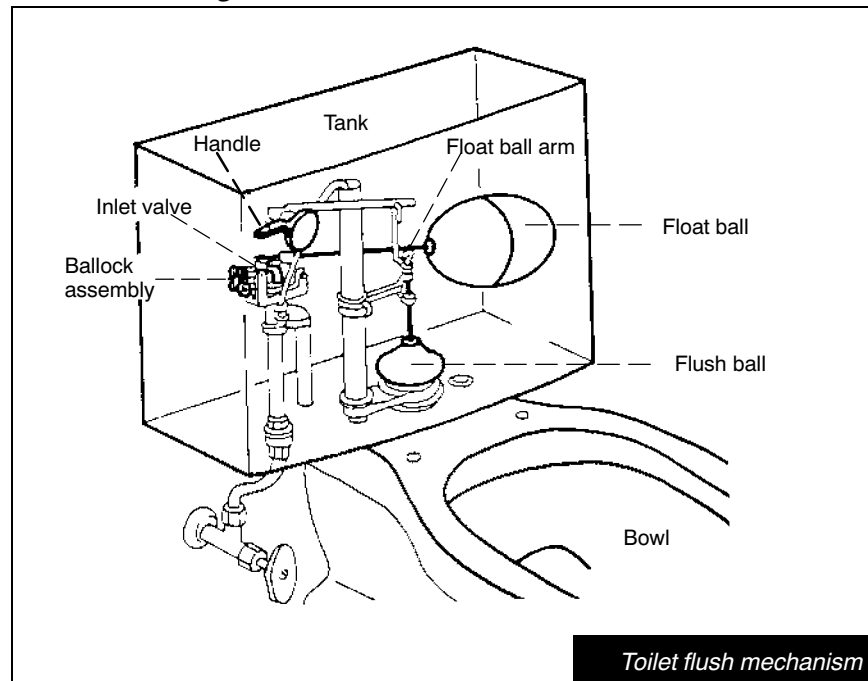

Operation and Maintenance

The only things you should put down a toilet are human or pet waste and toilet paper. Neither the toilet nor the sewage treatment system is designed to handle things like tampons, diapers and pet litter.

Clean the toilet bowl and exterior surfaces as necessary, using a commercial, non-abrasive, all-purpose cleaner, or baking soda and mild detergent.

The tank has an insulated liner. Nevertheless, condensation can form if the weather is warm and humidity high. If high levels of condensation are likely to damage the floor, put a drip pan under the tank. Remember to drain and clean the pan often.

Additional Tips

- ⦿ Often, if the tank is leaking steadily into the toilet bowl, you can hear it; however, small leaks, which over time can waste a lot of water, are hard to hear. Lift the lid of the tank from time to time and check that the toilet flushing mechanism is working well. Pour a few drops of food colouring into the toilet tank; if the water in the bowl discolours in an hour or so, there is a leak.
- ⦿ The tank dam is a common and easily installed water-conserving device that reduces the amount of water per flush. These dams, available at hardware stores, are easy to install on most toilets; however, they are not recommended for low-flush toilets. Another type of water-conserving device, available through some municipalities, maintains tank volume but reduces the amount of water wasted as the tank refills: it can be used with low-flush toilets.

**Builder's or
Homeowner's Notes**

OUTSIDE FAUCET (HOSE BIB)

Additional Tips

Water from a leaking faucet or hose can seep into the basement and damage the foundation wall. Repair leaks immediately or, if a delay is unavoidable, turn off the inside valve until you can solve the problem.

Protect access to the hose faucet's inside shut-off valves. Even if you finish the basement, build access panels that are at least 30 cm x 30 cm (12 in. x 12 in.) in size. Do not insulate the water line that serves the hose connection: this line goes from the basement through the foundation wall to the outside; if insulated from the warm basement air, it could freeze and crack in cold weather.

If you use your hose to fill a pool, and if the water level in the pool is higher than the faucet, install an anti-siphon device on the faucet: this will prevent pool water from backing up into your plumbing system. Remove the anti-siphon device in the fall when you drain all outdoor pipes and hoses.

Description

The outside faucet for your garden hose connection is located in the foundation wall of your house, not far above ground level. You may have more than one outside faucet.

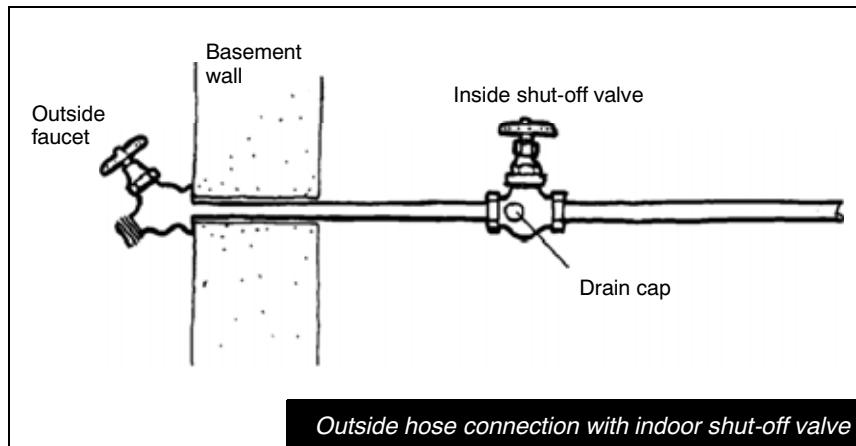

Operation and Maintenance

Frozen water can burst pipes. Before winter arrives, close down and drain the outside hose connection and the hose itself.

Your “freeze-proof” outside faucet has a single shut-off located on an outside wall; but the valve in the pipe is actually just inside the point where the pipe enters the house, which is why it will not freeze. Firmly close the shut-off before winter freeze-up. Disconnect and drain the hose and store it indoors.

In addition to the outside faucet, your hose connection has another shut-off valve inside the house. Before winter, close the hose connection as follows (in order):

- Shut off the inside valve.
- Disconnect and drain the hose.
- Open and drain the outside faucet.
- Unscrew by one full turn the small cap (the drain cap) located behind the handle of the inside valve. Let any water left in the faucet drain out, then retighten the drain cap.
- Close the outside faucet.

Part Two — Plumbing and Hot Water

After winter is over, open the hose connection as follows (in order):

- Check that the drain cap is tight and that the outside faucet is closed.
- Open the inside valve fully, then turn it back a half turn.
- Check that there is no leak between the inside valve and the basement wall or outside the house. If you spot a leak, close the inside valve and check that you completed the previous steps correctly. If the leak persists, temporarily repair any damaged plumbing (*Troubleshooting, General Information*, page 141) and call a plumber.

Builder's or Homeowner's Notes

WELL WATER SUPPLY SYSTEM

Troubleshooting

Insufficient water supply: For those dependent on wells, the water supply may fluctuate with seasonal changes in the water table. Compensate, if you can, by managing and reducing your demand for certain purposes (e.g., lawn watering). An investment in water-conserving fixtures (e.g., showerheads and toilets) and appliances (e.g., clothes washers and dishwashers) may also help (*Faucets*, page 149 and *Toilets*, page 157). If capacity is an ongoing problem, however, call on a plumber to do a well draw-down test and suggest solutions (e.g., an additional or larger storage tank in the house for peak use or low supply periods).

Poor water pressure: Open all *Shut-Off Valves* (page 144) to their fullest extent and, if necessary, adjust pressure settings on the pressure tank. If these measures do not solve the problem, check the pressure tank manual for instructions. Leaks in the plumbing system (*General Information*, page 141) or obstruction in the pipes (*Drains and Traps*, page 151) may also cause a loss of pressure.

Dirty or discoloured water: The well may be running low: stop using the water for a while or reduce your demand and see if water quality improves. Alternatively, if you have been away and are just beginning to use your plumbing again, the water may contain a higher than normal level of leached minerals. In either case, you will not see clear water again until that which has been standing in the well and the tank moves through the system. If the problem continues, have the water tested.

Pump not working: Consider the range of possible causes:

Description

A well supplies water to your house. Water seeps naturally out of the surrounding terrain and collects in the well, from which it is pumped through buried pipes to the house. Your pump may be a submersible pump in the well or a jet pump near the storage tank.

The water pipe from the well to the house may have a heating cable in it to prevent freezing or it may be buried deep enough to protect it from freezing.

A pressure (storage) tank stabilizes water flow and is the immediate source of water whenever a fixture turns on in the house. In effect, the tank acts as a storage buffer between water in the well and water used by the household. Usually located in the basement, the pressure tank is partly filled with compressed air. The air pressure drops as the water level goes down. When it drops to around 25 psi (175 kPa), the pump turns on; well water flows into the tank until the pressure reaches 50 psi (350 kPa); then the pump shuts off. The result is less wear on the pump, as it is called into service only periodically to replenish a large quantity of water in the tank, rather than frequently and for short bursts every time a tap is turned on in the house.

Your water system may be equipped with the following additional items:

- an ion-exchange water softener to remove high levels of magnesium and calcium from the water;

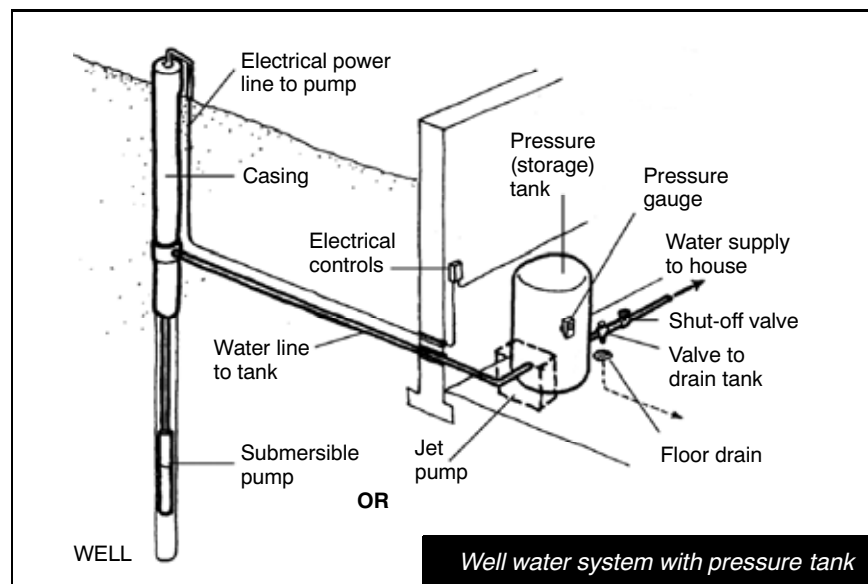

Troubleshooting Cont'd.

- An interruption in the electricity supply. Make sure that the pump is “ON” at the switch, then check the circuit breaker at the electrical panel (*Electrical System*, page 167). If the source of the problem is still unclear, look for a poor electrical connection or broken line.
- A faulty pressure tank switch. Consult the manual.
- A frozen supply line. If you have a heating cable, check that it is “ON” at the switch and at the electrical panel (*Electrical System*, page 167).
- A frozen pump. If you have a submersible-type pump, it may have frozen. Remove it from the well and thaw it out.
- A seized or burned out pump. Replace it.

A short on-off pump cycle: If the pump comes on every time you use a little water — for example, filling a glass from the tap — the water in the storage tank may have absorbed the pressurized air. This is not a serious problem, nor is it difficult to correct; nevertheless, you should address it promptly to avoid wear and tear on the pump. Consult the tank manufacturer’s instructions or contact a well service contractor.

Additional Tips

An insulation jacket on the pressure tank reduces the risk of corrosion from condensation.

-  Once the risk of frost is past, you no longer need heating cables in the outside supply pipe. Save energy in the summer by switching the cable off at the circuit breaker in the electrical panel (*Electrical System*, page 167).

- a particle filter to strain out sediments;
- an oxidizing filter to remove iron or hydrogen sulfide;
- an activated carbon filter to remove potentially hazardous organic chemical compounds; or
- a chlorine feeder unit for disinfection.

Operation and Maintenance

When necessary, you can turn off the pump and the heating cables at the circuit breaker in the electrical panel (*Electrical System*, page 167).

From time to time, inspect the pump and any filters or associated water treatment equipment. Read the product manuals to learn about the maintenance and servicing needs of this equipment.

Have the water tested every year, or whenever it has an unusual odour, is discoloured or has visible particles in it. Many local health departments test water free of charge and advise on issues relating to potable water (e.g., the availability and value of special equipment to improve water quality).

Builder’s or Homeowner’s Notes

Location of well and well specifications (e.g., type, depth, casing).

Pump specifications (e.g., make and size) and, if it is a jet pump, location.

Location of switch for pump and heating cable.

Additional information on filters, water softeners, etc.

SEPTIC SYSTEM OR HOLDING TANK

Troubleshooting

Smell from the septic field: A bad smell is the first sign that your system is not functioning well. You may also notice bright green spots on the lawn and soft, spongy sections of ground. To investigate, buy a special tracer dye and flush it into your septic system. Watch the area of the septic tank and field: if signs of dye appear soon afterwards, it suggests that wastes are moving straight through the system without processing. Seek the advice of an expert immediately.

Dark liquid coming up from the field: If the field oozes when walked on, there is a serious problem. Again, seek immediate service.

Additional Tips

Avoid overloading the septic system with heavy water use over a short period. Stagger the highest water-consuming activities (e.g., washing clothes and bathing). Also, use low-flow toilets, showerheads and other fixtures and appliances to reduce the risk of overloading (*Toilets*, page 157 and *Faucets*, page 149).

A normal septic field lasts 25 to 30 years, but good management can prolong its life. Do not allow trees, shrubs or plants with roots deeper than those of grass to grow within 3 m (10 ft.) of the septic system. Maintain a consistent ground level over the field. Prevent erosion and the pooling of water, both of which adversely affect the functioning of the septic field. Do not drive over the septic tank and field or put heavy loads on the ground in that area.

Description

Your house is equipped with a private system for disposal and treatment of wastewater from your plumbing fixtures.

- A septic system is usually comprised of a buried septic tank (a watertight, two-compartment container) and septic field (also known as a tile bed, leaching bed, drain field or soil absorption field). The sewage drain pipe vents the tank to plumbing vents in the roof (*General Information*, page 141).

In the tank, bacteria begin to break down sewage, and the wastes separate out into three parts: solid waste (sludge) on the bottom; light waste (scum) on the surface; and liquid waste between. The liquid drains off into the septic field on your property. (You can sometimes spot the location of the septic field, as the grass there tends to be exceptionally healthy and green.) The septic field consists of a buried network of pipes punctured with small holes. The liquid from the septic tank slowly drains through these holes in the pipes and into the soil. Do not confuse the septic system's "tile bed" with the weeping tiles buried around the house, which drain groundwater away from the foundations (*Foundations and Basements*, page 49).

Your house may not have a septic field. Instead, waste from your plumbing system is stored in a holding tank.

Some of your basement plumbing fixtures may stand at a lower level than the drain to your septic system. The fixtures drain to an internal sanitary storage tank in your basement. A float in the storage tank, when it reaches a certain level, activates the pump, which then discharges waste to the septic tank or main holding tank.

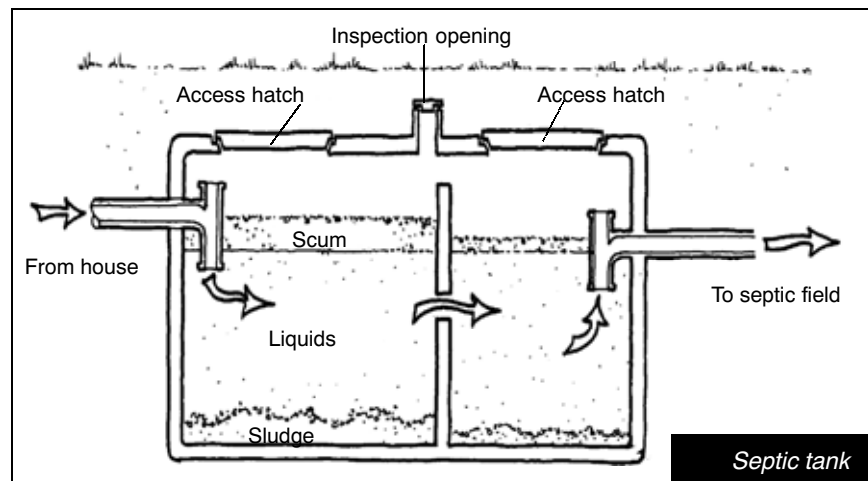

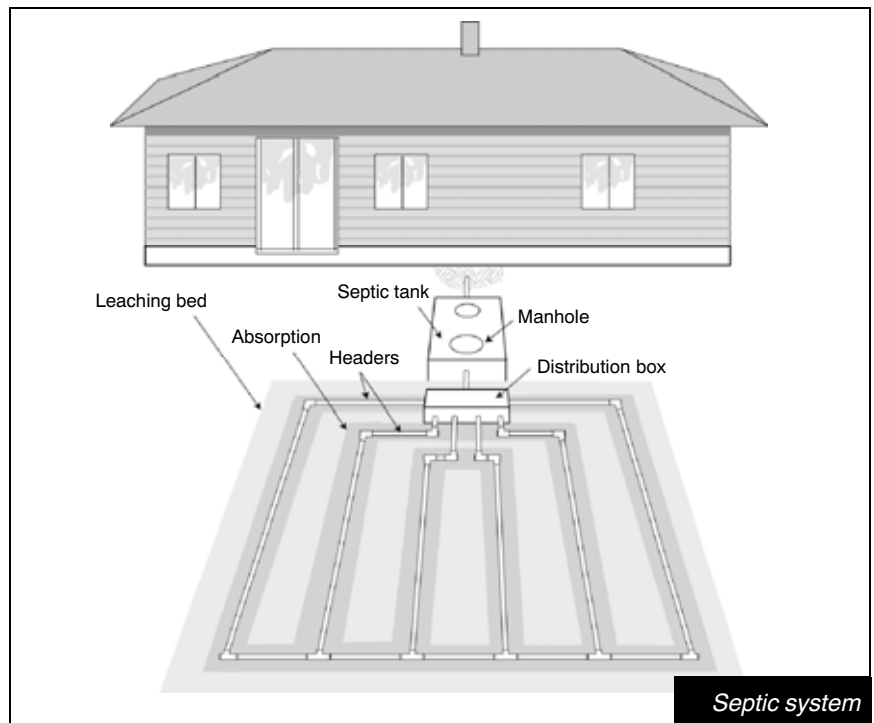

Operation and Maintenance

Have the septic tank inspected annually and pumped out every two to four years — more frequently, if you have a holding tank instead of a septic field. Your local health department may recommend a qualified contractor. Even if landscaping hides the site of the septic or holding tank, make sure that the access hole (manhole) and inspection openings are not blocked.

- ☞ In some jurisdictions, the frequency of cleaning is set by law, regardless of the size of the system or household.

Chemicals can interfere with natural bacterial action in a septic system. Restrict the kind and volume of chemicals that go into your system, including those commonly found in cleaners and drain openers (e.g., solvents, bleaches, disinfectants, acids and caustic solutions). As well, do not pour paint thinner, pesticides or photo-developing chemicals into your drains or toilets.

The only solids that should go into the septic system are body waste and toilet tissue. Do not put anything else into the drain system (e.g., grease, coffee grounds, dental floss and sanitary napkins).

- ☞ Commercial tank treatments can lead to clogged lines in the septic field.

Septic System or Holding Tank

**Builder's or
Homeowner's Notes**

Location of tank.

Location of septic field.

PART TWO

ELECTRICAL SYSTEM

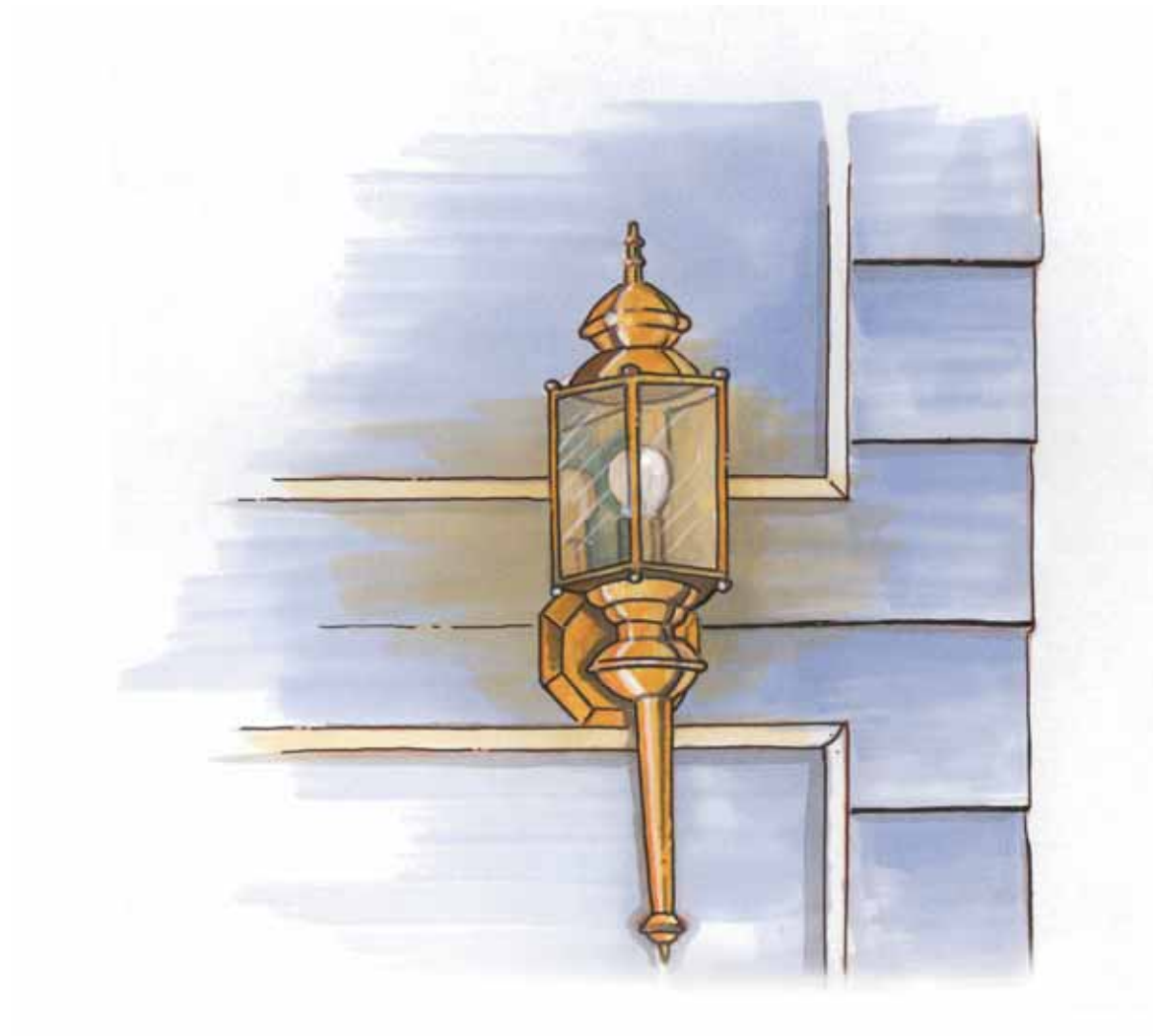

GENERAL INFORMATION

Troubleshooting

Power cuts out on a circuit:

Follow these steps to determine the cause of the power cut and to restore the power to the circuit:

- Check the breakers at the electrical panel. A tripped breaker toggle will have shifted position in relation to others: it may be found in a middle position, with a red dot or other mark visible on the breaker; however, some breakers simply switch to “OFF.”
-  If the problem relates to a receptacle with a ground fault circuit interrupter, try pressing the reset button before checking the breaker panel.
- Before resetting the breaker, ensure that the circuit is not overloaded. If there were numerous lighting fixtures or appliances in operation on the circuit when the breaker tripped, or even just a few appliances with high power demand, turn some off.
- To reset the breaker, move it first — if it is in the middle position — to “OFF,” then back in the opposite direction to the position marked “ON.” Wait a few seconds to see if it trips again.
- If the breaker trips again, there is likely a short circuit. First, check all electrical cords for frayed wires or loose connections and disconnect any appliance where you spot a problem. If the breaker trips again, the problem is probably in the house wiring rather than in an appliance. Call an electrician.

System Overview

The electrical supply is delivered to your house through either a buried or an overhead cable. The voltage at the point of delivery is 120/240 volts at 60 cycles per second. This supply powers the appliances, lights, exhaust fans, etc., in your house, as well as other electrical devices plugged into the electrical receptacles (outlets) throughout the house.

A meter on the outside wall of your house measures your household’s use of electricity. Your meter may be: in the basement, in the garage, separate from the electrical panel, or on the panel.

The main electrical switch, which you can use to shut off the power to the whole house, is usually found close to the meter.

The electrical panel is a large metal box containing the circuit breakers, which should be labelled to indicate which appliances or areas of the house they serve.

An electrical circuit is a closed loop linking the power source to an electrical “load” (e.g., a lighting fixture, electrical appliance or other piece of electrical equipment). Current flows through the circuit to and from the electrical panel. A “hot” wire carries current through an insulated electrical cable to the load, and a neutral wire carries it back again to the panel. A single circuit may connect quite a few small loads, such as lights and small appliances. Major appliances, such as fridges, stoves, dryers and air conditioners, have their own circuits.

Circuit breakers are current-sensitive switches or toggles mounted in the electrical panel. When the circuit breaker is in the “OFF” position, the circuit is interrupted, and no power flows to the appliances or receptacles on that circuit. The breaker “trips” (cuts off power) when too much current is drawn through the cable. This protects against overheating the cable in an electrical circuit and, ultimately, against fire. For example, a short circuit can occur when the insulation around a “hot” wire wears thin, and the wire comes into contact with another wire to create a power surge. A hot wire coming into contact with water — which is an excellent conductor — can also cause a “short.” Refer to the *Troubleshooting* section for guidance on restoring power to a circuit whose breaker has tripped.

Electrical receptacles (outlets) have plug-ins for two three-pronged plugs. The two parallel prongs, one of which — the neutral prong — may be wider than the other, carry the electrical power. The third prong, a round one, connects to a ground wire, which protects against short circuits. The ground wire is “grounded” (connects) to the metal water

Additional Tips

Foreign-made appliances and equipment may be designed for either a 240- or a 120-volt system, and they must be set to 120 volts before they are used in Canada. (Before purchasing an appliance abroad, make sure that it can be used at 120 volts.)

- ⓘ Compact fluorescent bulbs can be screwed into regular light bulb sockets. They deliver the same amount of light as regular (incandescent) bulbs but use about one-fifth the energy. Use compact fluorescent bulbs in any fixture that takes a 60W or greater incandescent bulb, and that is used an average of three or more hours a day. While they are more expensive to buy, these bulbs more than pay for themselves through the energy they conserve over their long lifetime.

supply pipe next to the water shut-off valve or to ground rods in the earth outside the house.

Ground fault circuit interrupters are special electrical receptacles installed in bathrooms, garages and outside the house, where the presence of water involves a particularly high risk of shock. These receptacles shut the power off immediately whenever there is a leakage of current. All bathroom receptacles may be governed by a single reset button in one of the bathrooms. Each outside receptacle usually has its own reset button.

Important Safety Tips

- ⓘ Though you can generally rely on the electrical system in your house, you should be aware of a few potential dangers.
 - If there is any water around, be careful of any source of electricity. If you are standing in water or in contact with it, or if the wiring is wet, you must not touch the main switch or any part of the electrical system nor operate an electric appliance. Before opening the door of your electrical panel, make sure your hands are dry, as well as the floor beneath your feet.
 - Do not repeatedly reset a breaker that trips. If you cannot find and correct the cause of the short circuit (see *Troubleshooting*), call an electrician immediately.
 - If you have an overhead electrical supply cable, be careful when working outside the house not to touch it.
 - If you have a buried electrical supply cable, contact your electric utility company, as well as other utility companies (gas, cable, telephone) before digging.
 - When using an extension cord, unroll the whole thing. Leaving wiring tightly rolled can cause overheating and even fire.
 - Do not pull plugs from receptacles by the wire. Grip the plug itself.
 - Protect small children by covering any unused receptacles within their reach with purpose-made covers (available at any hardware store). Keep appliances and lamp cords out of the way of infants and remove cords that might trip someone.

For greater safety and certainty, make sure that any electrical appliance you buy is approved (and labelled) by the Canadian Standards Association (CSA) or Underwriters Laboratories of Canada (ULC).

Operation and Maintenance

A switch on the wall at the entrance to a room usually controls the overhead light fixture. If there is no overhead fixture, the switch controls the upper receptacle on one of the outlets along the wall. The switch will activate any floor or table lamp plugged into that receptacle, as long as the lamp is switched “ON.”

Hinged covers protect outside receptacles from rain. Keep this cover closed when the receptacle is not in use.

Periodically test your ground fault circuit interrupters. Press the “TEST” button while a fixture is on. If the power to the fixture shuts off, the interrupter is working. Then press the “RESET” button to restore power to the receptacle.

Before replacing a light bulb, make sure the fixture is turned off. Never exceed the watt maximums indicated on the sticker on the fixture.



If a bulb has broken and you have to unscrew it by holding the metal base, turn off the power to the circuit first. Set the breaker to “OFF” at the electrical panel.

To change a fluorescent tube, gently rotate the old tube until it releases. Insert the new tube by sliding the prongs at either end into the slots. Rotate the tube about a quarter turn to fix it in place.

Make sure that household members all know the location of—and how to use—the main electrical switch and the breakers in the electrical panel. In the event of flooding or any situation that makes electricity dangerous, turn the power off at the main switch. But do this only if you are able to stand in a dry place while touching the panel. (See *Important Safety Tips*.)

Builder’s or Homeowner’s Notes

General Information

HOMEOWNER'S MANUAL

CONGRATULATIONS ON THE PURCHASE OF YOUR NEW HOME!!

Well you've worked hard and long, searched far and wide, and that day has finally come... You've found that perfect home! Now you ask yourself: "How do I keep it perfect?"

At CMHC we feel that it's only natural that there be an operator's manual for the biggest, most important, most expensive purchase of your life... Your Home!! This is why CMHC provides products to better maintain your home from day one and in the years to come.



This *Homeowner's Manual* is just the beginning. CMHC also provides such products as:

How to Lock out Crime: Protecting Your Home Against Burglary

This manual promotes a proactive, community based approach to safety. It walks you through home security from A to Z. An excellent source for advice on how to make your home and neighbourhood more secure. Order # 61124 - \$9.95.

Home Care: A Guide to Repair and Maintenance

A complete well-illustrated guide to operating your home from housekeeping tips to putting together a basic tool kit, from replacing a light switch to painting and controlling condensation. Ideal for anyone moving into their first home. Order # 61019 - \$6.95

FlexHousing: Homes that Adapt to Life's Changes

FlexHousing involves designing and building living spaces that are adaptable, accessible, affordable and convertible. This magazine is packed with information about Flex features inside and outside the home. Order # 61844 - \$9.95

CMHC also has a wide variety of other publications to help you with your new home. All of which can be found in the *Before You Renovate* catalogue (order # 61001-FREE). These publications have detailed illustrations, helpful planning guides, and provide countless useful tips on the maintenance and care of your new home. CMHC believes in maintaining the quality and care of the home, and wants to be there with you every step of the way for yours.

Please visit the [About your House Factsheet](#) series on our website for additional information on maintaining your home. www.cmhc.ca

Call to order: 1-800-668-2642

61841



www.cmhc.ca

ISBN 978-0-660-18815-7

